

**HUBEN<sup>®</sup>**  
INSIDE

**LENAGA<sup>®</sup>**



**KATALOG**  
**FURNITURE FITTINGS & LIGHTING**  
EDISI 06

Scan QR Code dibawah untuk mengikuti update terbaru dari Huben Indonesia!



Website  
Huben Indonesia



E-Katalog  
Tarikan



E-Katalog  
PVC Sheet



@hubenindonesia



Huben Indonesia



Huben Indonesia



@hubenindonesia

# Daftar Isi

---

<b>AMBALAN .....</b>	<b>1-2</b>
<b>BRACKET &amp; PIPA GANTUNG .....</b>	<b>2-3</b>
<b>ENGSEL SENDOK .....</b>	<b>4-9</b>
<b>KUNCI .....</b>	<b>10-13</b>
<b>MINIFIX .....</b>	<b>14</b>
<b>LIGHTING .....</b>	<b>15-19</b>
<b>LAIN-LAIN .....</b>	<b>20-27</b>
<b>PLAT STRIP .....</b>	<b>28-29</b>
<b>PROFIL ALUMINIUM .....</b>	<b>30-37</b>
<b>RAK DAPUR .....</b>	<b>38-40</b>
<b>RODA .....</b>	<b>41-46</b>
<b>REL LACI .....</b>	<b>47-59</b>
<b>TARIKAN .....</b>	<b>60</b>

# HUBEN<sup>®</sup>

## Sertifikasi SGS

### Telah Teruji

Scan Untuk  
Sertifikat Lengkap



## REL TANEM



### Ketahanan Karat

**SGS** **KAN**

**TEST REPORT** No: IDHG2310013248R2 Date: August 11, 2023 Page 2 of 3

**HUBEN**  
JAKARTA, INDONESIA

**Test Conducted:**  
Salt Spray Test

**Test method:** ISO 9227:2017

**Test conditions:**  
Concentration of solution collected: 5% NaCl (w/v)  
Chamber temperature: (35±2)°C  
Volume of salt solution collected: (1.0-2.0) ml(100±1) μl  
pH of collected solution at (23±3)°C: 6.5-7.2  
Exposure period: 24h

**Test results:**

Component	Appearance Rating (AR)	Observation	Protection Rating (RP)
REL TANEM TN 37-450 Slide Motion K03-CH	R0	Moderate colour change due to deterioration of the coating	R10

Note: Appearance rating refers to EN ISO 10289:2001, as follows:

Area of defects, A (%) (5mm defects)	Appearance rating
0 < A ≤ 0.1	10
0.1 < A ≤ 0.25	9
0.25 < A ≤ 0.5	8
0.5 < A ≤ 1.0	7
1.0 < A ≤ 1.5	6
1.5 < A ≤ 2.0	5
2.0 < A ≤ 3.0	4
3.0 < A ≤ 5.0	3
5.0 < A ≤ 10	2
10 < A ≤ 20	1
20 < A ≤ 50	0

- Kapasitas Beban **30kg**
- Siklus Pemakaian **80.000 Kali**

## ENGSEL



### AP-L4 Ketahanan Karat

### Siklus Pemakaian 50.000 Kali

**SGS**

**TEST REPORT** No: SDHL24010129MPT.1 Date: Mar 27, 2024 Page 2 of 7

**TESTS AND RESULTS**

**Test Conducted:**  
ISO 9227:2017 Corrosion Tests in Artificial Atmospheres - Salt Spray Tests

**No. of Sample:**  
2 pieces (Sample #1 & sample #2). For more sample information and pictures, please refer to the following page.

**Test conditions:**  
Test Method: Neutral Salt Spray  
Concentration of NaCl Solution: 50 g/l ± 5 g/l  
pH of Salt Solution: 6.5-7.2  
Measure of the salt fog fall: (1.0 ± 0.5) ml(100±4) μl  
Test Duration: 48 hours  
Test Temperature: (35 ± 2) °C

**3. Observation Rating (Established based on ISO 10289:2001)**

Specimen No.	Exposure Period	Area of Defects A (%)	Protection Rating (RP)
1	12 hours	0	R10
2	24 hours	0	R10
3	36 hours	0	R10
4	48 hours	0	R10

**Remarks:**  
1. This test report is to supplement to: SDHL24010129MPT.1 test report which was issued on Jan 28, 2024. And the original test results (paper and electronic) are ready.  
2. For the sample pictures, please refer to the following page.

**SGS**

**TEST REPORT** No: SDHL24060106MPT Date: Jun 26, 2024 Page 2 of 3

**TESTS AND RESULTS**

**Test Conducted:**  
Hinge durability test with reference to clause 6.3.7 of EN 10376:2008

**No. of Sample:**  
2 pieces. For more sample information and pictures, please refer to the following page.

**Test and Requirements**

Test and Requirements	Test Results
<b>Hinge Durability Test</b> About five members, 1 kg each, one on each side of the door at the middle of the vertical dimension. Pull down the door by a maximum of 100 mm by close to the bottom of cylinder (back and forth), without forcing both in close in the open position. The door shall be gently opened and closed at each cycle without forcing components and/or catch devices including self-opening and self-closing mechanism. Approximately 1.5 shall be used for opening and 1.5 for closing the door. If the hinges have detenters and/or catch devices, including self-opening and self-closing mechanisms, these shall be allowed to operate normally according to their function at each cycle. After the test, the hinges and their components shall fulfil their functions.	PASS

**Remarks:**  
1. Loading door size: 800 mm H x 700 mm W x 10 mm T.  
2. Weight of loading door: 8.2 kg.  
3. The cyclic number of 50,000 cycles is operated by applicant.  
4. For the sample information and pictures, please refer to the following page.



### SM-L4 Ketahanan Karat



### LENAGA<sup>®</sup> EK-L4 Ketahanan Karat

**SGS** **KAN**

**TEST REPORT** No: IDHG2310013248R2 Date: August 11, 2023 Page 2 of 3

**HUBEN**  
JAKARTA, INDONESIA

**Test Conducted:**  
Slide durability test with reference to clause 6.3.8 of EN 10338:2007+A1:2010

**No. of Sample:**  
2 pieces. For more sample information and pictures, please refer to the following page.

**Test and Requirements**

Test and Requirements	Test Results
<b>6.3.8 Durability test</b> Load capacity: 30 kg Cyclic number: 80,000 cycles Rate: 4 to 15 cycles per minute Requirement: The slide shall fulfill its function.	PASS

**Remarks:**  
1. The cyclic number = 80,000 cycles and load capacity = 30 kg (including the weight of the testing device) were specified by applicant.  
2. The dimension of testing device is 545 mm H x 487 mm D x 120 mm H.  
3. For the sample information and pictures, please refer to the following page.

**SGS** **KAN**

**TEST REPORT** No: IDHG2310001889 Date: March 06, 2024 Page 2 of 9

**HUBEN**  
JAKARTA, INDONESIA

**Test Conducted:**  
Salt Spray Test

**Test item:** Salt Spray Test

**Test method:** ISO 9227:2017

**Test conditions:**  
Concentration of solution collected: 5% NaCl (w/v)  
Chamber temperature: (35±2)°C  
Volume of salt solution collected: (1.0-2.0) ml(100±1) μl  
pH of collected solution at (23±3)°C: 6.5-7.2

**TEST RESULTS:**

**Exposure period: 12 hours**

Component	Appearance Rating (AR)	Observation	Protection Rating (RP)
SM-L4 CLIP-ON SOFF CLOSE HINGE	R10	No Change	R10
SCREWS	R10	No Change	R10
HUBEN LOGO PLATE	R10	No Change	R10

**Exposure period: 24 hours**

Component	Appearance Rating (AR)	Observation	Protection Rating (RP)
SM-L4 CLIP-ON SOFF CLOSE HINGE	R10	No Change	R10
SCREWS	R10	No Change	R10
HUBEN LOGO PLATE	R1	Slight Colour change due to deterioration of the coating	R10

**SGS** **KAN**

**TEST REPORT** No: IDHG2310001867 Date: March 06, 2024 Page 2 of 8

**HUBEN**  
JAKARTA, INDONESIA

**Test Conducted:**  
Salt Spray Test

**Test item:** Salt Spray Test

**Test method:** ISO 9227:2017

**Test conditions:**  
Concentration of solution collected: 5% NaCl (w/v)  
Chamber temperature: (35±2)°C  
Volume of salt solution collected: (1.0-2.0) ml(100±1) μl  
pH of collected solution at (23±3)°C: 6.5-7.2

**TEST RESULTS:**

**Exposure period: 12 hours**

Component	Appearance Rating (AR)	Observation	Protection Rating (RP)
EK-L4 CLIP-ON SOFF CLOSE HINGE	R10	No Change	R10
SCREWS	R10	No Change	R10

**Exposure period: 24 hours**

Component	Appearance Rating (AR)	Observation	Protection Rating (RP)
EK-L4 CLIP-ON SOFF CLOSE HINGE	R9	Very Slight Color change due to deterioration of the coating	R10
SCREWS	R9	Very Slight Color change due to deterioration of the coating	R10

## AMBALAN



**AB-813**  
**Ambalan Besi Bulat**  
 Material : Besi  
 Finish : Nickel

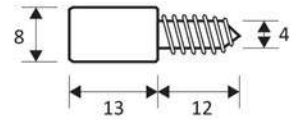

**AJ-7**  
**Ambalan Jepit (Skrup)**  
 Material : Zinc Alloy  
 Finish : Nickel

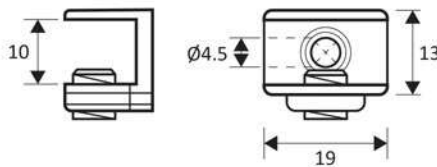

**AJ-9**  
**Ambalan Jepit (Pin)**  
 Material : Zinc Alloy  
 Finish : Nickel

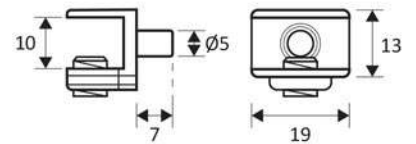

**AKP-15-SS**  
**Ambalan Kaca Plat**  
 Material : Stainless Steel  
 Finish : Nickel

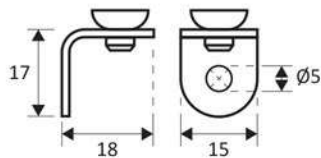

**AKZ-14**  
**Ambalan Kaca Zinc**  
 Material : Zinc Alloy  
 Finish : Nickel

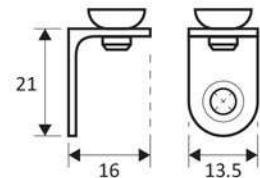

**AK-04**  
**Ambalan Tanpa Karet**  
 Material : Zinc Alloy  
 Finish : Nickel

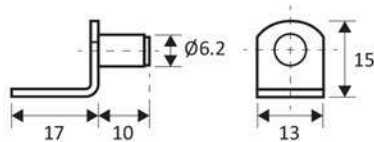

**AK-06**  
**Ambalan Karet**  
 Material : Besi Plat  
 Finish : Galvanized

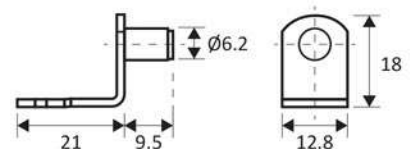

**RH-13**  
**Ambalan Kaca**  
 Material : Zinc Alloy  
 Finish : Nickel

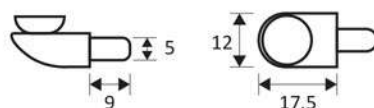

**AB-5**  
**Ambalan Bening**  
 Material : Besi & Plastik  
 Finish : Galvanized

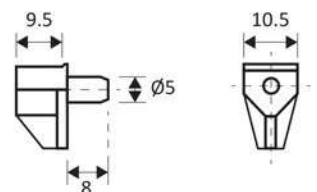



## RH-21 Ambalan Besi Ring

Material : Besi  
Finish : Nickel

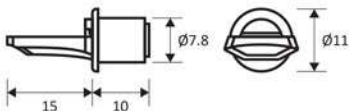

## F-004 Ambalan Jepit Kaca

Material : Zinc Alloy  
Finish : Nickel

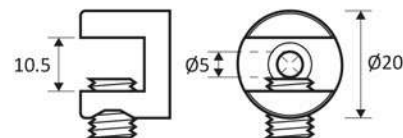

## BRACKET & PIPA GANTUNG



### Bracket

Tersedia Diameter  
Ø 19 & 25 mm



BP



PT



PU



### Bracket



BP-16

## HUBEN®

STAINLESS STEEL

### PSS-19 & PSS-25 Pipa Bulat

Diameter : 19 & 25 mm  
Panjang : 3 m

### PSS-1530 Pipa Oval

Ukuran : 15 x 30 mm  
Panjang : 3 m

## HUBEN®

BESI CHROME

### PBC-25 Pipa Bulat

Diameter : 25 mm  
Panjang : 1.05 & 3 m

### PBC-1530 Pipa Oval

Ukuran : 15 x 30 mm  
Panjang : 3 m

## LENAGA®

STAINLESS STEEL

### LPS-25 Pipa Bulat

Diameter : 25 mm  
Panjang : 3 m

### LPS-1530 Pipa Oval

Ukuran : 15 x 30 mm  
Panjang : 3 m



## BP-16

### Bracket Pipa Oval

Material : Zinc Alloy

Finish : Nickel

Diameter : 16 mm

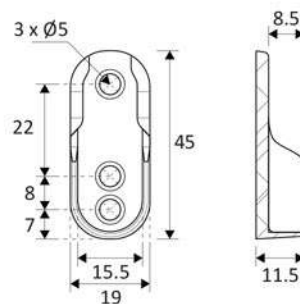

## BP-19 & BP-25

### Bracket Pipa Topi

Material : Zinc Alloy

Finish : Chrome

Diameter : 19 & 25 mm

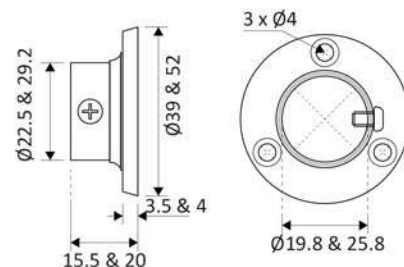

## PT-19 & PT-25

### Bracket Tiang Tengah

Material : Zinc Alloy

Finish : Chrome

Diameter : 19 & 25 mm

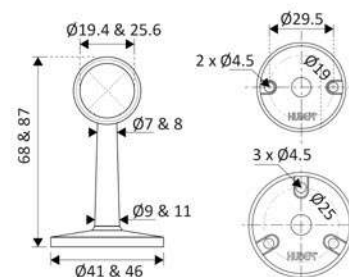

## PU-19 & PU-25

### Bracket Tiang Ujung

Material : Zinc Alloy

Finish : Chrome

Diameter : 19 & 25 mm

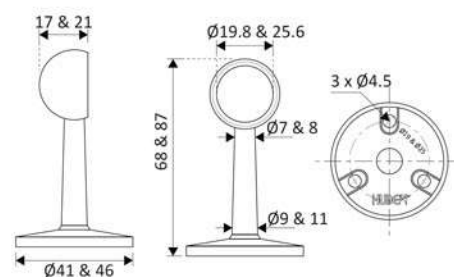

## ENGSEL SENDOK



### Engsel Frame Aluminium

**Slow Motion** *Klip-on*

**EFA-0-HT**

Lurus

**EFA-8-HT**

Semi Bungkuk

**EFA-16-HT**

Full Bungkuk

Material : Besi Plat

Finish : Nickel (Hitam)

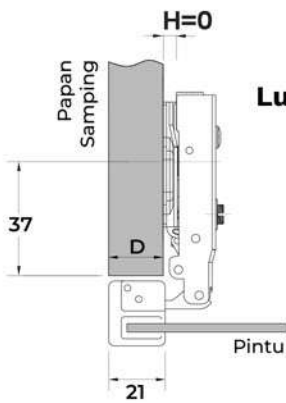
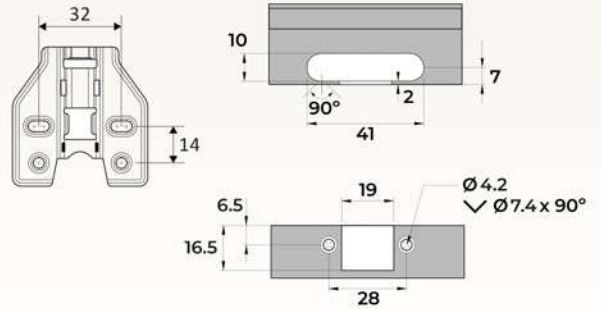

**Lurus (0)**

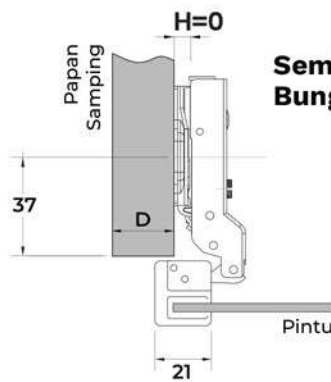

**Semi Bungkuk (8)**

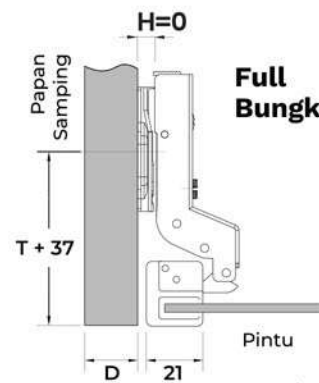

**Full Bungkuk (16)**

\* D ≤ 21







## Engsel Sendok 165°

**Slow Motion** *Klip-on*

**E-180-SM-0**  
Lurus

**E-180-SM-8**  
Semi Bungkuk

**E-180-SM-16**  
Full Bungkuk

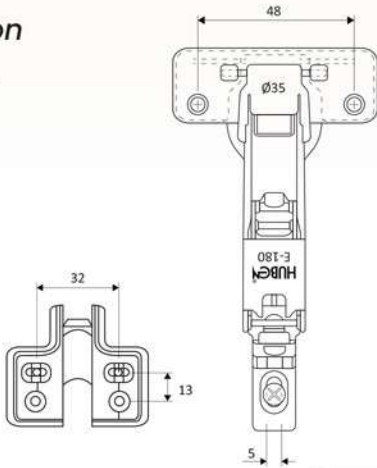

## Engsel Bifold 135°

*Slide-on*

**BIFOLD-135**

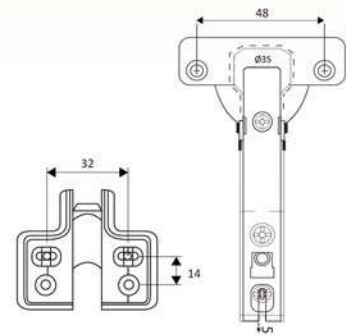

Material : Besi Plat  
Finish : Nickel

### Lurus (0)

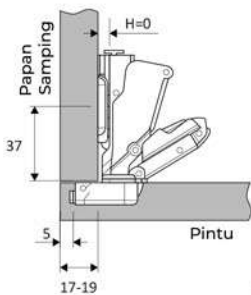

### Semi Bungkuk (8)

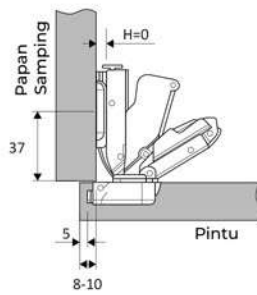

### Full Bungkuk (16)

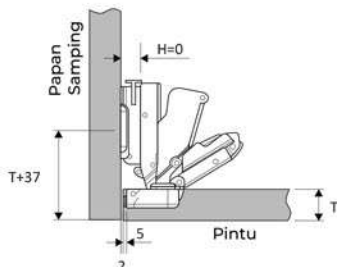

### KOMBINASI E-180-SM & BIFOLD-135

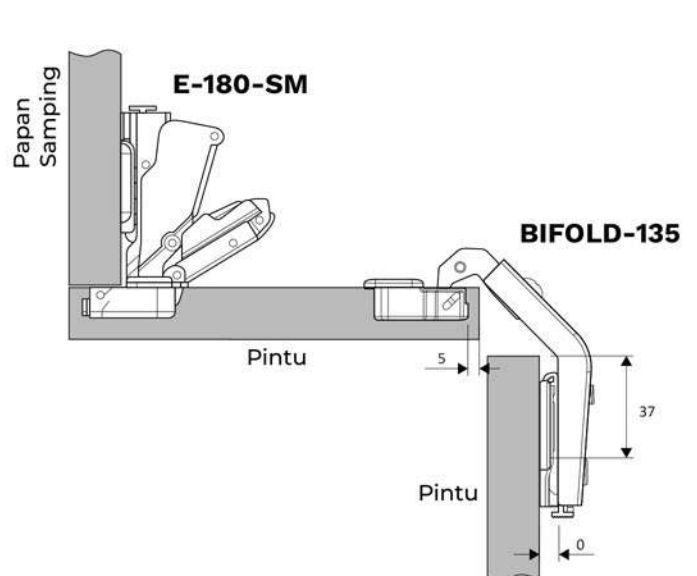

**HUBEN®**



## Engsel Sendok

**Slow Motion** Klip-on

**SM-0-L4**

Lurus

**SM-8-L4**

Semi Bungkuk

**SM-16-L4**

Full Bungkuk

Sertifikat  
**SGS**



**LENAGA®**



## Engsel Sendok

**Slow Motion** Klip-on

**EK-0-L4**

Lurus

**EK-8-L4**

Semi Bungkuk

**EK-16-L4**

Full Bungkuk

Sertifikat  
**SGS**



Material : Besi Plat  
Finish : Nickel

### Lurus (0)

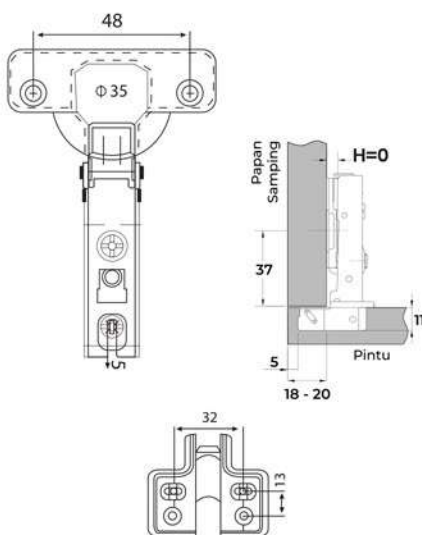

### Semi Bungkuk (8)

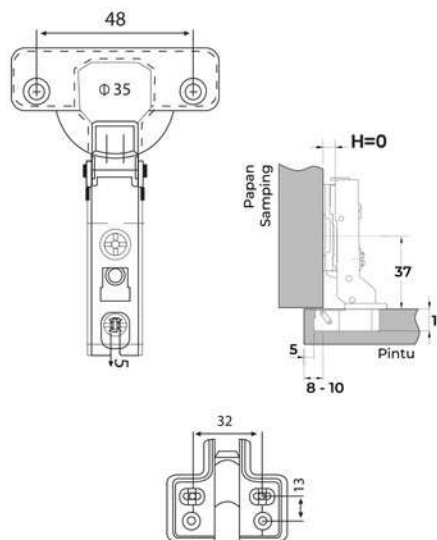

### Full Bungkuk (16)

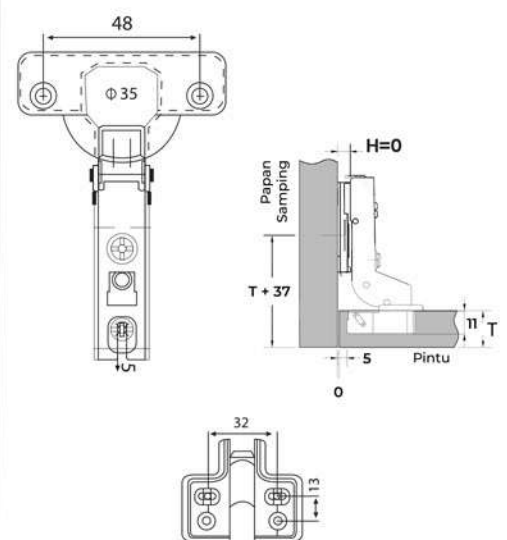



## Engsel Sendok Klip-on

**SUS-0-L4**  
Lurus

**SUS-8-L4**  
Semi Bungkok

**SUS-16-L4**  
Full Bungkok

**Stainless Steel**

**Slow Motion**

Material : Stainless Steel  
Finish : Stainless Steel

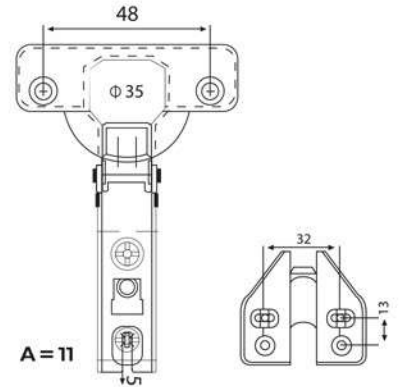

## Engsel Sendok Klip-on

**AP-0-L4**  
Lurus

**AP-8-L4**  
Semi Bungkok

**AP-16-L4**  
Full Bungkok

**Sertifikat SGS**



**Slow Motion**

Material : Besi Plat  
Finish : Nickel

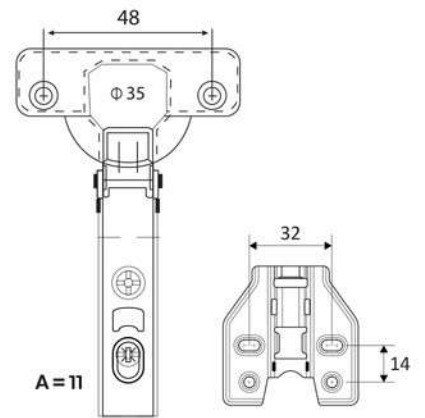

## Engsel Sendok Slide-on

**HT-0-L4**  
Lurus

**HT-8-L4**  
Semi Bungkok

**HT-16-L4**  
Full Bungkok

Material : Besi Plat  
Finish : Nickel

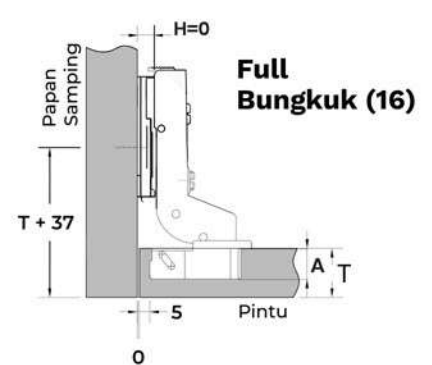
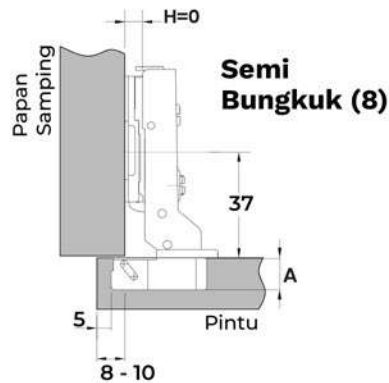
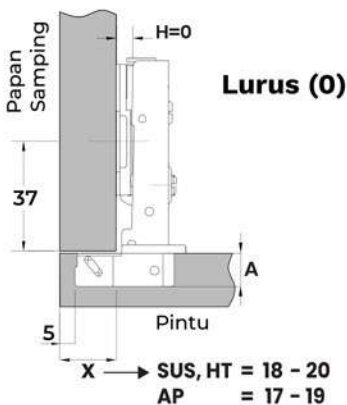
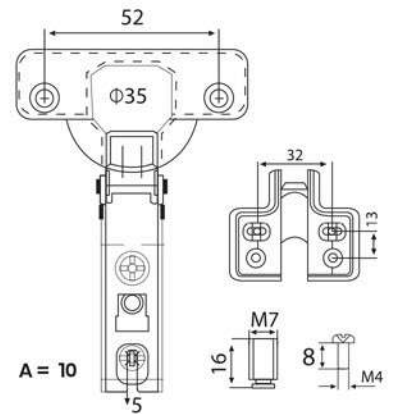



## Engsel Sendok Slide-on

**HB-0-L4**  
Lurus

**HB-8-L4**  
Semi Bungkok

**HB-16-L4**  
Full Bungkok

Material : Besi Plat  
Finish : Nickel

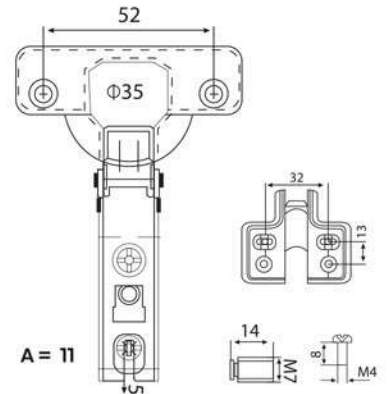

## Engsel Sendok Slide-on

**MT-0-L4**  
Lurus

**MT-8-L4**  
Semi Bungkok

**MT-16-L4**  
Full Bungkok

Material : Besi Plat  
Finish : Nickel

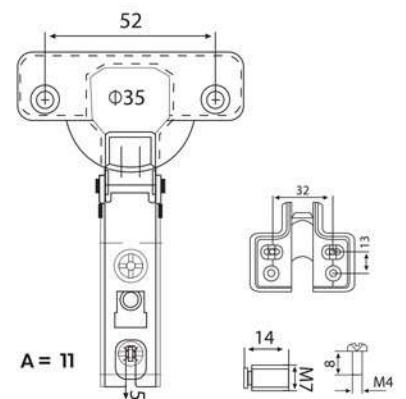

## Engsel Sendok Slide-on

**MH-0**  
Lurus

**MH-8**  
Semi Bungkok

**MH-16**  
Full Bungkok

Material : Besi Plat  
Finish : Nickel

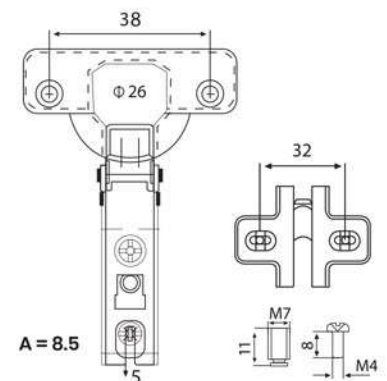

**Mini**

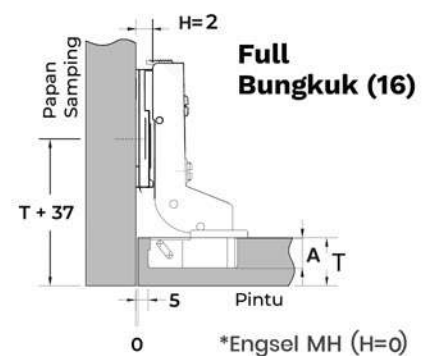
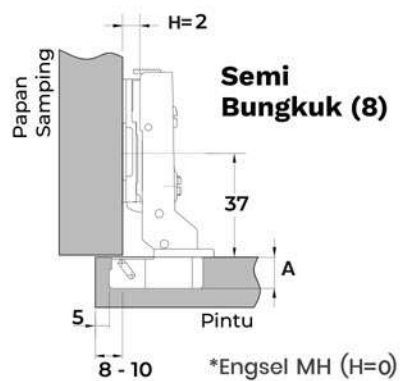
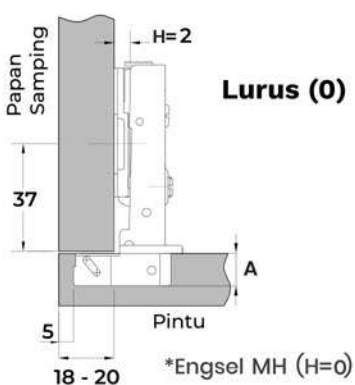



**Slow Motion**

## Engsel Sendok Kaca *Klip-on*

**KS-0-L4**  
Lurus

**KS-16-L4**  
Full Bungkok

Material : Besi Plat  
Finish : Nickel



**Cover**

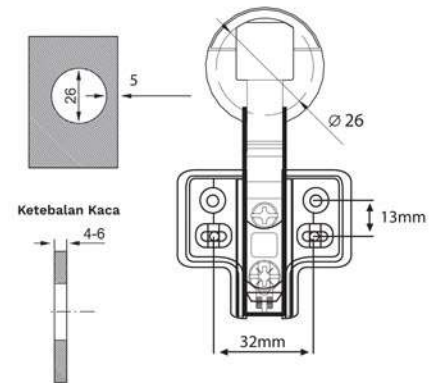

## Engsel Sendok Kaca *Key Hole*

**GH-0**  
Lurus

**GH-16**  
Full Bungkok

Material : Besi Plat  
Finish : Nickel



**Cover**

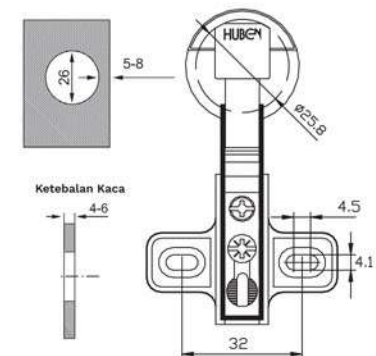

## Engsel Sendok Kaca *Slide-on*

**HEK-0-L4**  
Lurus

**HEK-16-L4**  
Full Bungkok

Material : Besi Plat  
Finish : Nickel



**Cover**

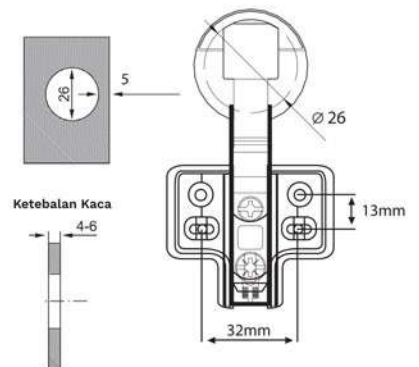

## KUNCI

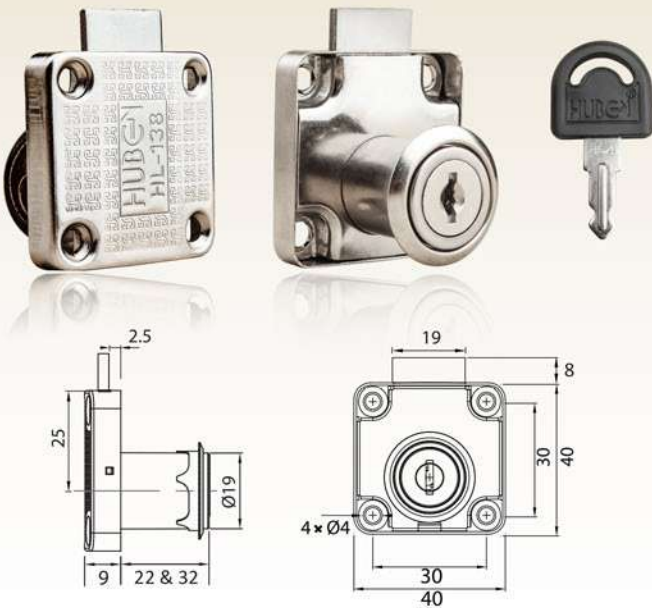

### HL-138

#### Kunci Kerangka Padat

Diameter Silinder : 19 mm  
 Panjang Silinder : 22 mm & 32 mm  
 Material Silinder : Zinc Alloy & Besi  
 Material Kerangka : Plat Besi



### HM-181-M2

#### Kunci Kerangka Kosong

Diameter Silinder : 19 mm  
 Material Silinder : Zinc Alloy  
 Material Kerangka : Plat Besi



### HL-202

#### Kunci Mekar

Diameter Silinder : 19 mm  
 Material Silinder : Zinc Alloy  
 Material Kerangka : Zinc Alloy



### HL-505-M2

#### Kunci Mekar

Diameter Silinder : 19 mm  
 Material Silinder : Zinc Alloy  
 Material Kerangka : Plat Besi



## HL-105 Kunci Tekan (Push Lock)

Diameter Silinder : 19 mm  
Material Silinder : Zinc Alloy  
Material Kerangka : Zinc Alloy

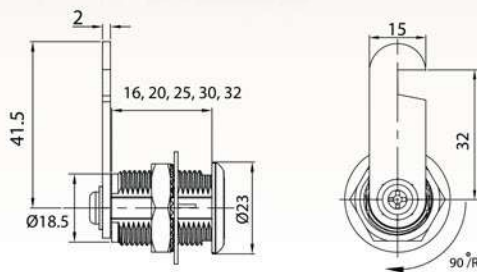
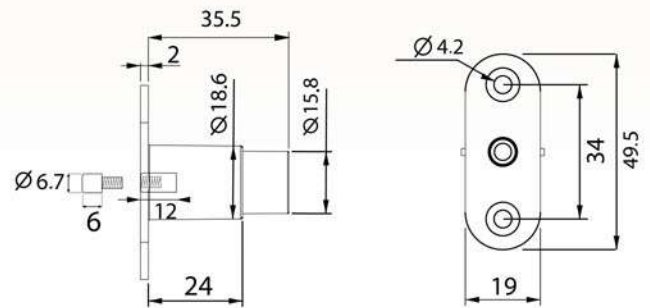

## HL-103 Kunci Camlock

Diameter Silinder : 19 mm  
Panjang Silinder : 16, 20, 25, 30, 32 mm  
Material Kerangka : Zinc Alloy

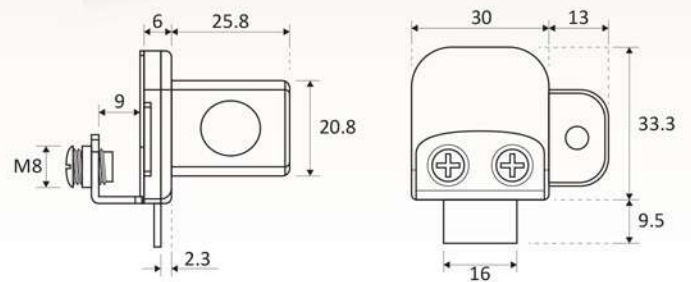

## HL-702 Kunci Kaca Kait Double

Diameter Silinder : 20 mm  
Material Silinder : Zinc Alloy  
Material Kerangka : Zinc Alloy  
Untuk Ketebalan Kaca : 4-8 mm

## HUBEN®

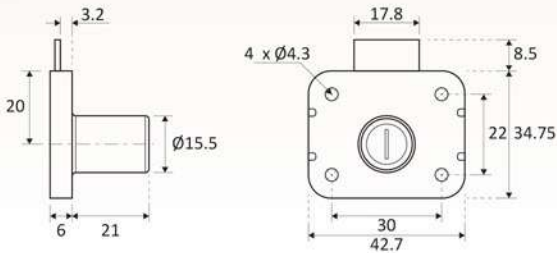

### HL-303 Kunci Laci

Diameter Silinder : 16 mm  
Material Silinder : Zinc Alloy  
Material Kerangka : Plat Besi

## LENAGA®

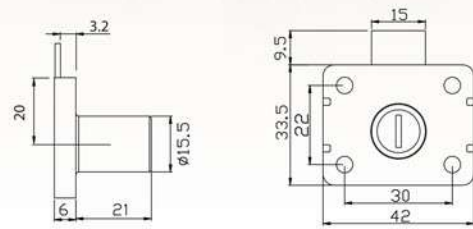

### LE-303 Kunci Laci

Diameter Silinder : 16 mm  
Material Silinder : Nylon  
Material Kerangka : Plat Besi

## HUBEN®

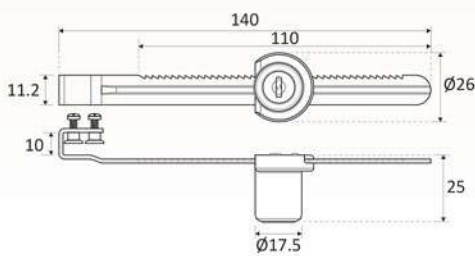
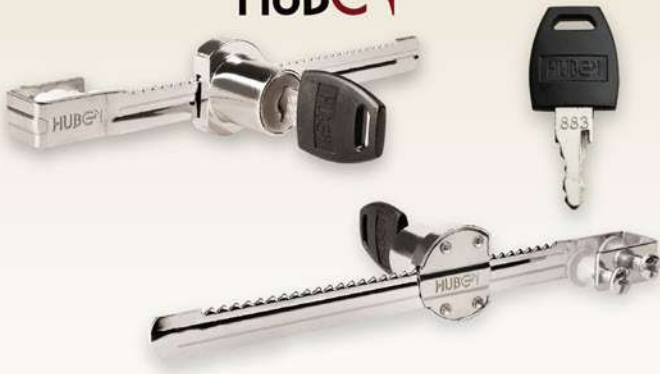

### HL-140 Kunci Gergaji

Diameter Silinder : 18 mm  
Material Silinder : Zinc Alloy  
Panjang Gergaji : 140 mm

*Segera Hadir*





## HL-108 Kunci Central Samping

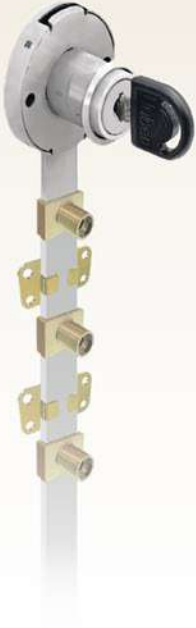

Diameter Silinder : 19 mm  
 Panjang Tiang : 60 cm  
 Material Silinder : Zinc Alloy  
 Material Tiang : Aluminium

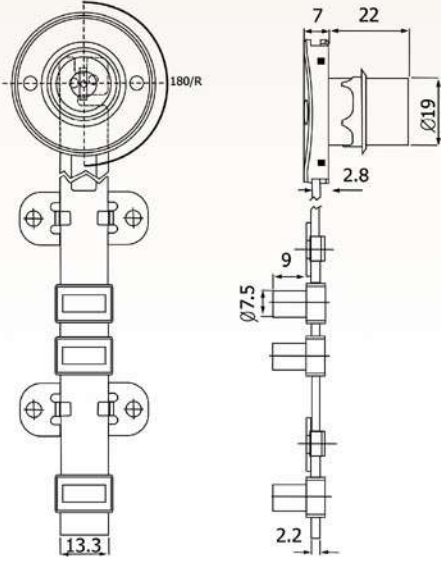

## HL-288 Kunci Central Depan Silinder & Tiang



Diameter Silinder : 19 mm  
 Panjang Tiang : 60 cm  
 Material Silinder : Zinc Alloy  
 Material Tiang : Aluminium

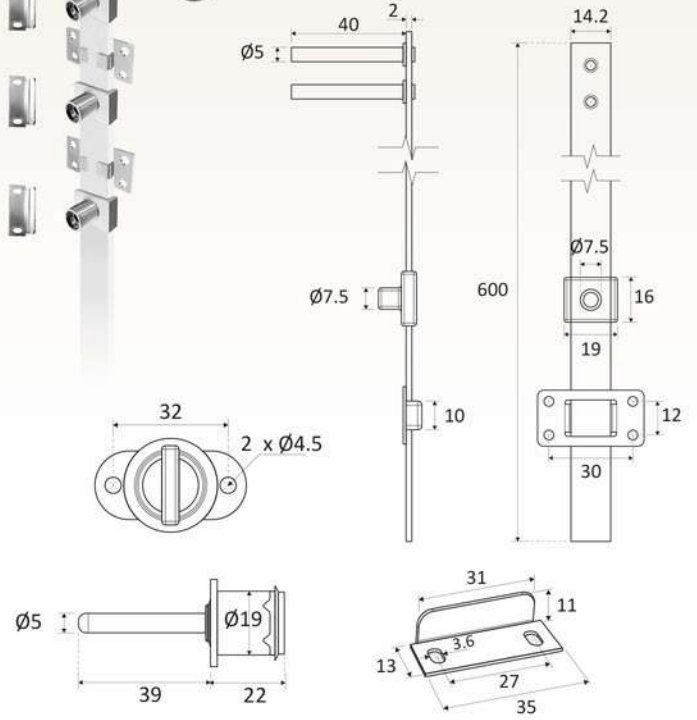

## HL-690 Kunci Espagnolette



Diameter Silinder : 18 mm  
 Panjang Tiang : 100 & 130 cm  
 Material Silinder : Zinc Alloy  
 Material Tiang : Besi  
 Material Kerangka : Zinc Alloy

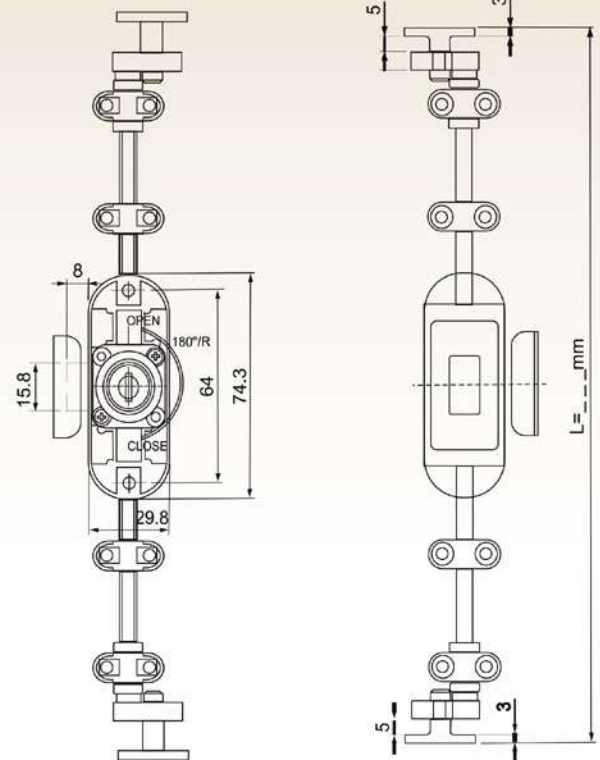
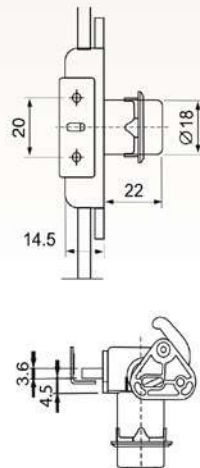

# HUBEN®

## MINIFIX



**MF-10-G**  
Casing Minifix  
Material : Zinc Alloy

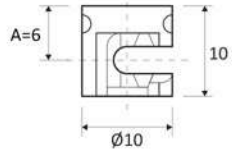

**MF-105**  
Casing Minifix  
Material : Zinc Alloy

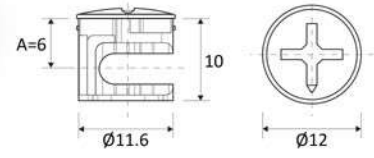

**MF-15-G**  
Casing Minifix  
Material : Zinc Alloy

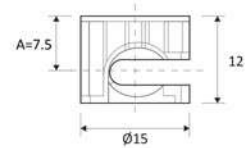

**HG-624**  
Skrup Minifix  
Material : Besi

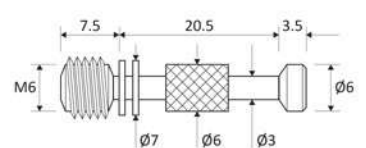

**KSF-5533-9**  
Skrup Minifix  
Material : Besi

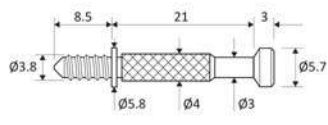

**KSF-6536-11**  
Skrup Minifix  
Material : Besi

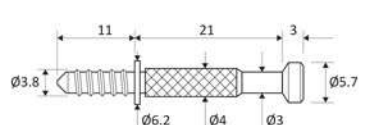

**DU-6249**  
Skrup Minifix  
Material : Besi

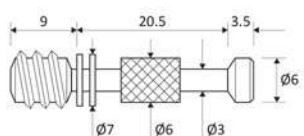

**DU-62411**  
Skrup Minifix  
Material : Besi

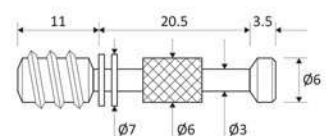

**NS-10, NS-10-B**  
Nylon Socket - M6 x 10mm  
Pasangan Skrup : HG-624

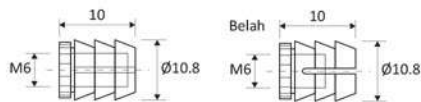

**DO-02**  
Camfix  
Warna : Coklat  
Material : Plastik & Zinc Alloy

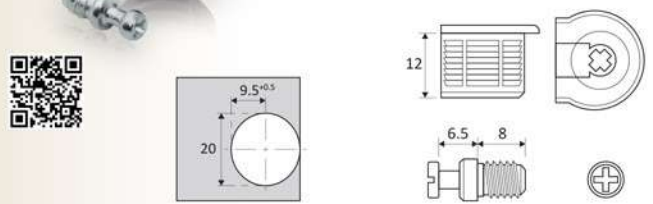

**Fisher**  
FIS-59 5 x 9 mm (Merah)  
FIS-512 5 x 12 mm (Putih)  
Pasangan Skrup : KSF-5533-9  
KSF-6536-11

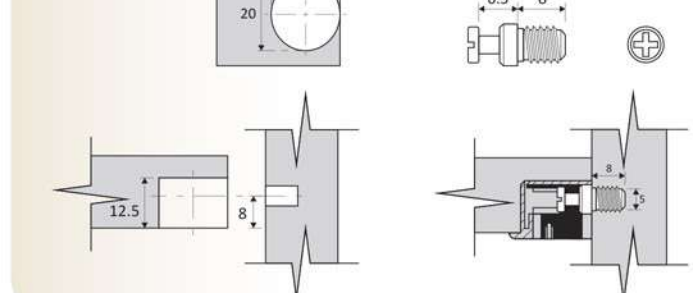
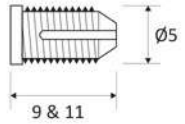

## LIGHTING

**LED STRIP**

**12V**

**5 meter / Rol**

**IP Rating 20**

### LED-COB-320



**COB 8 mm  
320 LED / m**

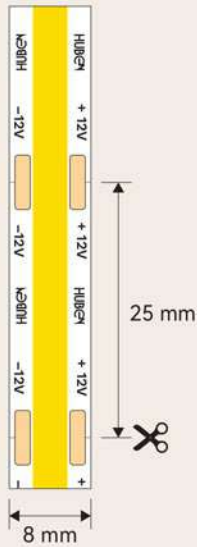

### LED-2835-120



**Mata Kecil  
120 LED / m**

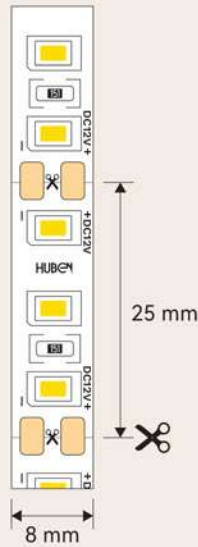

### LED-5050-60



**Mata Besar  
60 LED / m**

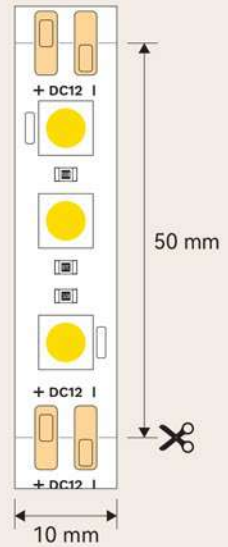

## TERSEDIA WARNA

**Kuning  
3000K**

**Natural  
4000K**

**Putih  
6500K**

## KONEKTOR LED STRIP

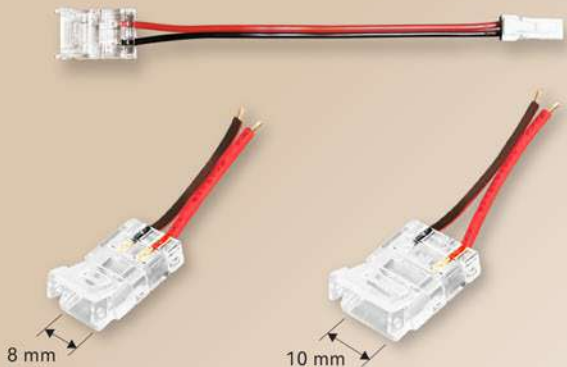

### KONEKTOR-LED-8

Untuk:  
- COB 8 mm  
- MATA KECIL

### KONEKTOR-LED-10

Untuk:  
- MATA BESAR



**Pemakaian ke Driver**

**Pemakaian ke Travo**



## VIDEO CARA PASANG

### Rumah Lampu BERIKUT LED Strip

**RULAM-10-LED**

**CAHAYA LAMPU LEBIH MERATA**

**BEBAS POTONG  
Dimana Saja**

**LANGSUNG COLOK  
Tanpa Solder**



### DRIVER 60W 12V

**DR-60-W**

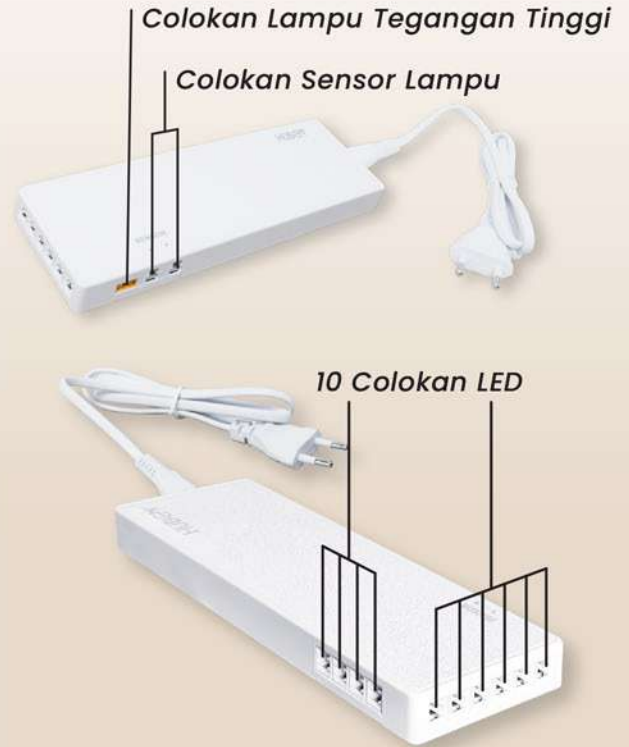

## AKSESORIS

### KABEL-10

*Kabel RULAM-10-LED*



Penutup

Bracket



### SENSOR-P-1

Sensor Lampu  
Pintu Single

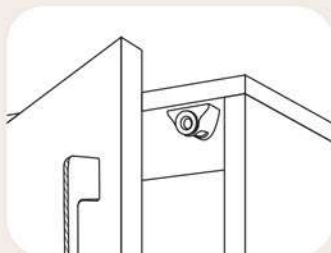

Dengan  
Perekat

### SENSOR-P-2

Sensor Lampu  
Pintu Double

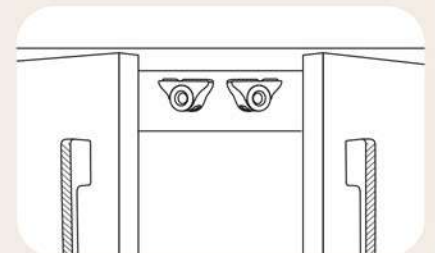



## DRIVER 60W 12V



Untuk Pasang  
**RULAM-10-LED**



Gunakan  
**KABEL-10**

Langsung Colok, Langsung Nyala

Untuk Pasang  
**LED STRIP**



Gunakan  
**KONEKTOR**

Langsung Pasang, Tanpa Solder





## TRAVO 100W 12V



**KABEL ON / OFF**  
*\*Dijual Terpisah*



Untuk Pasang  
**RULAM-10-LED**



Gunakan  
**KABEL-10**



Untuk Pasang  
**LED STRIP**



**KABEL BAWAAN  
LED STRIP**



Untuk Pasang  
**LED STRIP POTONGAN**



Gunakan  
**KONEKTOR**



Panjang : 3 Meter

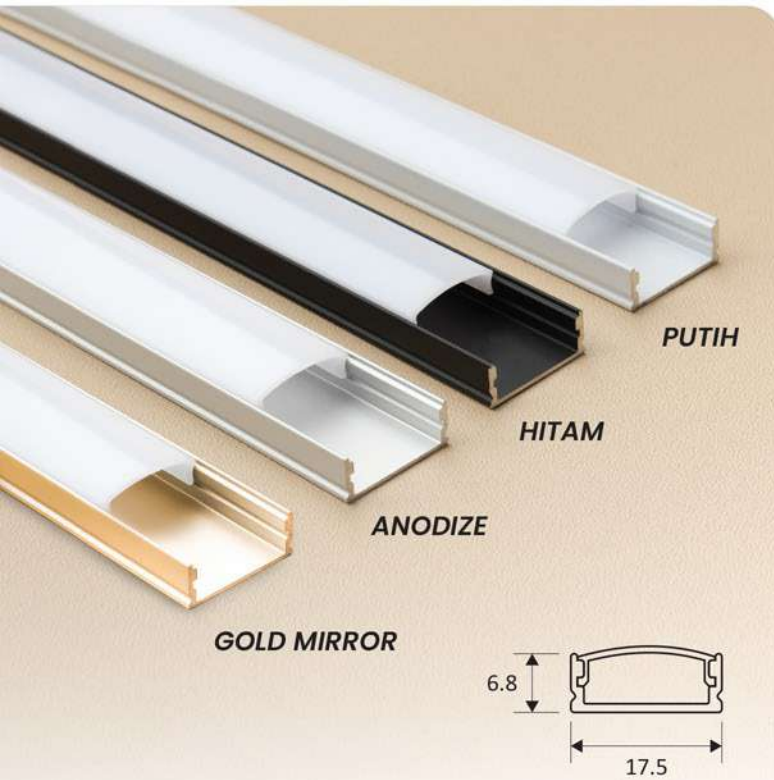

**RULAM-17**  
Rumah Lampu LED Strip



**RULAM-24**  
Rumah Lampu LED Strip



**RULAM-1616**  
Rumah Lampu Sudut

*Segera Hadir*

# HUBEN®



## PVC BOARD

UKURAN : 1220 x 2440 mm



KETEBALAN mm	KEPADATAN g / cm <sup>3</sup>
3	0.55
5	0.5
9	0.5
12	0.5
15	0.5
18	0.5

**Anti Rayap**



**Bebas Timbal**



**Banyak Kegunaan**

- ✓ Partisi
- ✓ Kitchen Set & Furnitur
- ✓ Papan Iklan, dll.

**Anti Air**



**Tidak Mudah Terbakar**







## PVC SHEET

Ketebalan : 0.3 mm

Kode Barang : PL, SK

*Tersedia lebih dari 120 pilihan warna*



## LAIN-LAIN

### Lubang Udara Aluminium

#### LUA-50

Finish : Anodize, Hitam, Gold  
 Panjang A : 150 - 200 - 250 - 300  
 Panjang B : A - 30

#### LUA-80

Finish : Anodize, Hitam, Gold  
 Panjang A : 150 - 200 - 250 - 300 - 350 - 400  
 Panjang B : A - 30

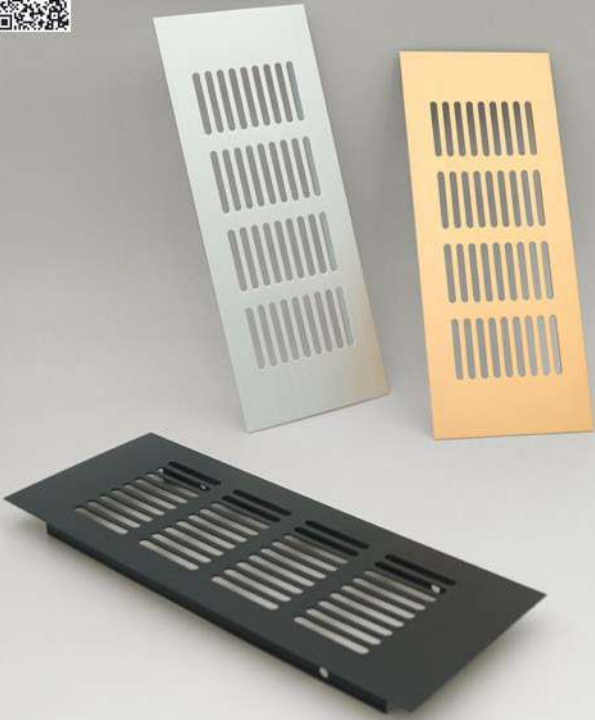
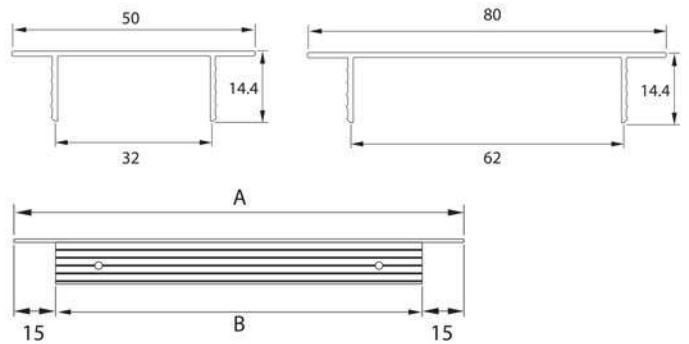

### Tip On

Tersedia Warna

- Putih
- Abu

#### TO-1 Plat Bulat



#### TO-2 Plat Persegi



Stainless Steel

### Tip On

#### TO-3-SS Plat Bulat





## WL-115 Junior Lift

Warna : Silver, Hitam  
Kapasitas Beban : 12kg

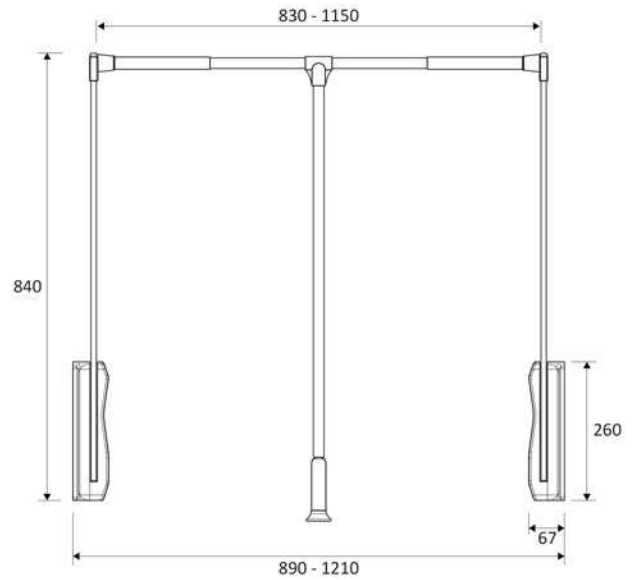

Slow Motion



## WL-200-SM Wardrobe Lift Slow-Mo

Warna : Silver, Hitam  
Kapasitas Beban : 10kg

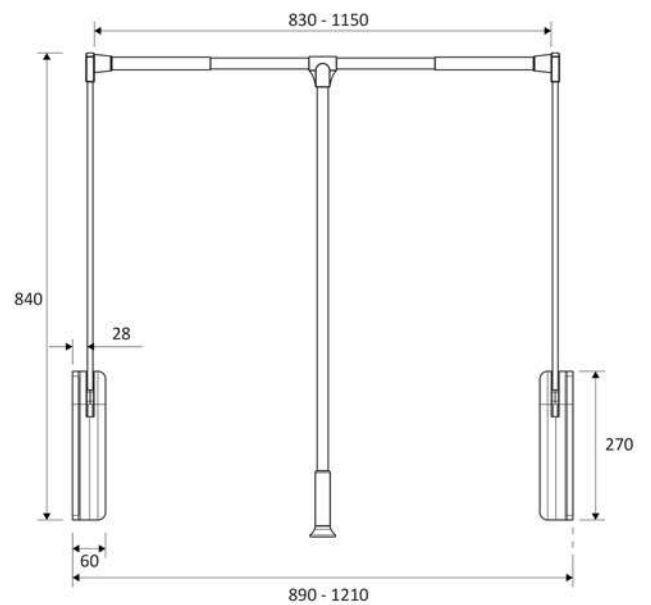



## GS Gas Spring

Mini 60N, 60N, 80N, 100N, 150N

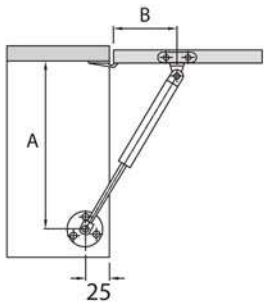

SUDUT BUKAAN	A	B
75°	260	80
90°	238	80
110°	215	70

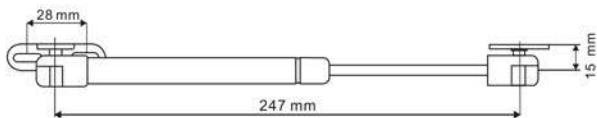

Slow Motion

## GSM Gas Spring Slow-Mo

80N, 100N, 150N

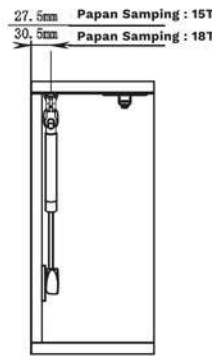

Tampak Depan

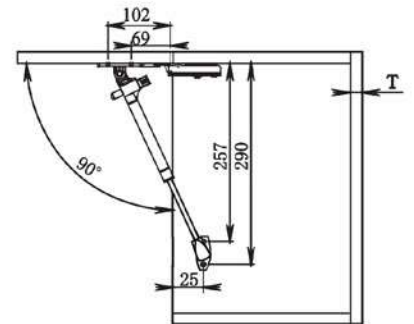

Tampak Samping



## PIK Pen Iklan SS

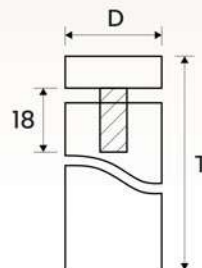

DIAMETER (D)	TINGGI (T)
12	20, 25, 30
16	20, 25, 30
19	20, 25, 30, 40, 50
25	25, 30, 40, 50
30	30, 40, 50

Dalam satuan millimeter (mm)

## Ring Meja Aluminium



**KM**

Tersedia Ukuran : 200, 300, 400, 500 mm



**RIMA**

Tersedia Ukuran : 300, 400, 500 mm

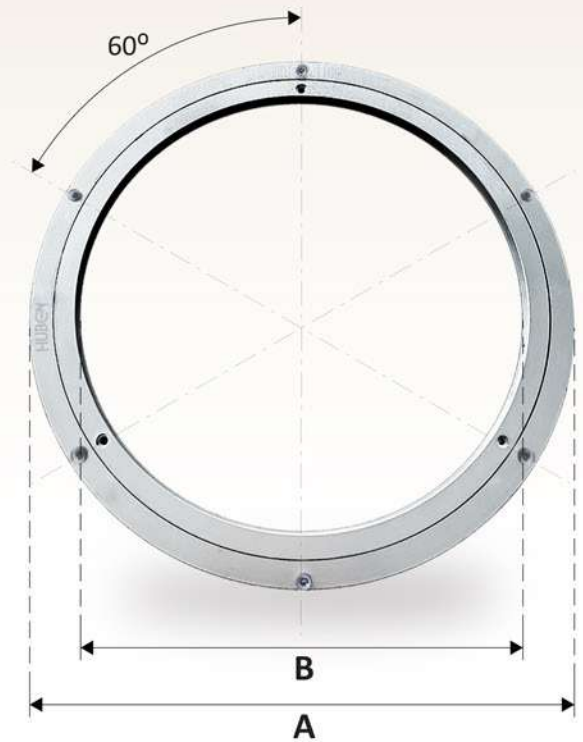
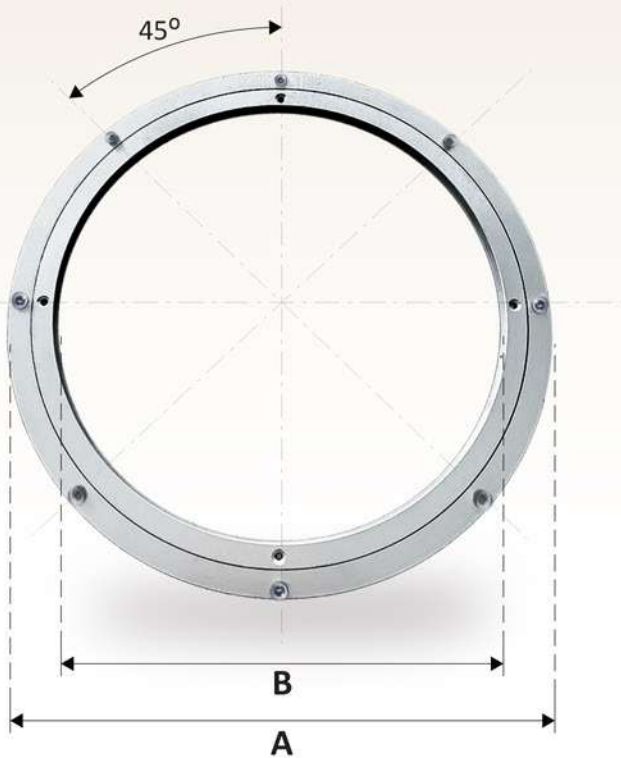

UKURAN	KM			RIMA		
	T	A	B	T	A	B
200	10	200	145	-	-	-
300	10	300	245	9	300	244
400	11	400	335	9	391	338
500	12	500	430	9	486	427



**T-86**  
Engsel Kaca Jepit  
Finish : Chrome

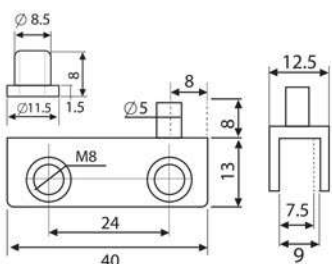

**PS-17**  
Push Single  
Material : Plat Besi  
Finish : Chrome

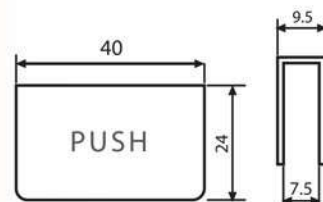

**GP-27**  
Grendel Tekan  
Warna : Coklat, Hitam,  
Putih

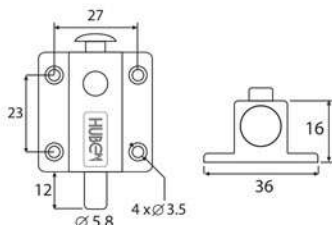

**TR-40**  
Trapes  
Warna : Coklat, Putih

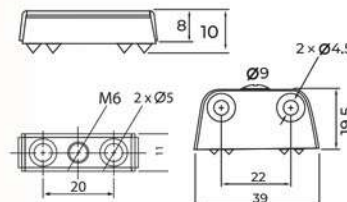

**MS-31**  
Magnet Single  
Warna : Hitam

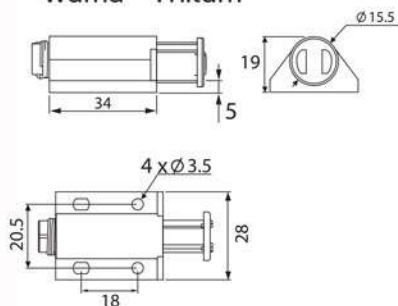

**MD-32**  
Magnet Double  
Warna : Hitam

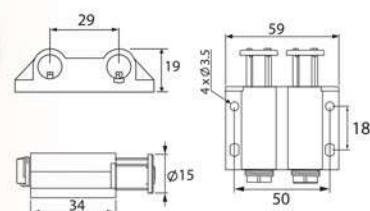

**MP-33**  
Magnet Persegi  
Warna : Coklat, Putih

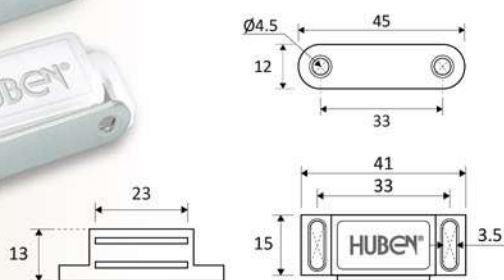

**MP-46**  
Magnet Persegi Besar  
Warna : Coklat, Putih

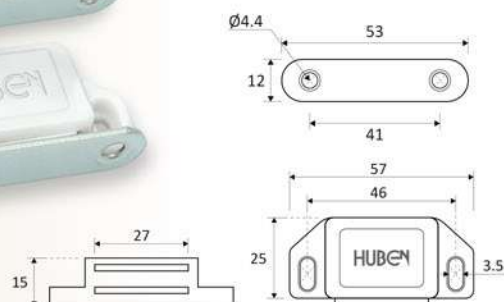



**ETRIM-40**  
Edging Trimmer SS  
Material : Stainless Steel

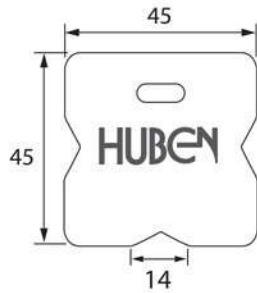

**AH-21**  
Siku Frame Aluminium  
Material : Plat Besi



**AH-45**  
Siku Frame Aluminium  
Material : Plat Besi

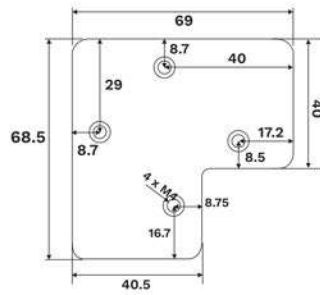

**SA-45**  
Siku Frame Aluminium  
Material : Aluminium

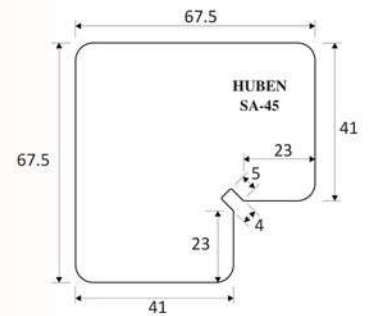

**Skrup-701**  
Baut Siku AH

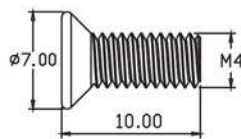

**BOS-447**  
Skrup Patah-patah  
Ukuran Ø: M4 x 47 mm

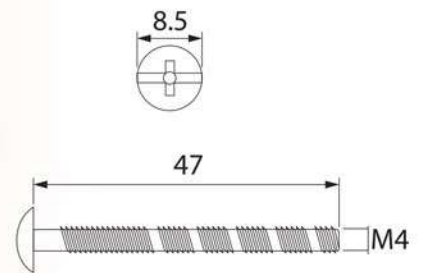

**SK-HF**  
Skrup Kaca Chrome  
Ukuran Ø: 10, 12, 14, 16, 18 mm

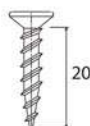

**SKSS**  
Skrup Kaca Stainless  
Ukuran Ø: 16, 19, 22, 25, 30 mm

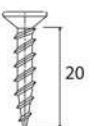

## PLAT STRIP

### STAINLESS STEEL

Panjang : 3.05 Meter



### Plat Strip Rata PSR

Tersedia Ukuran (mm):

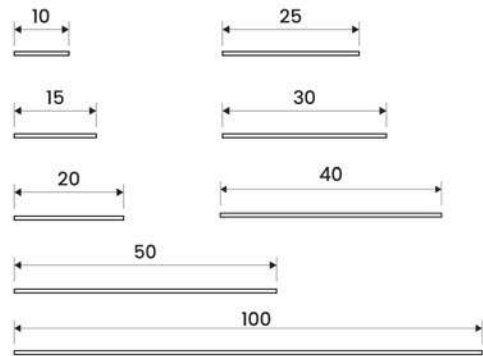

### Plat Strip L PSL

Tersedia Ukuran (mm):

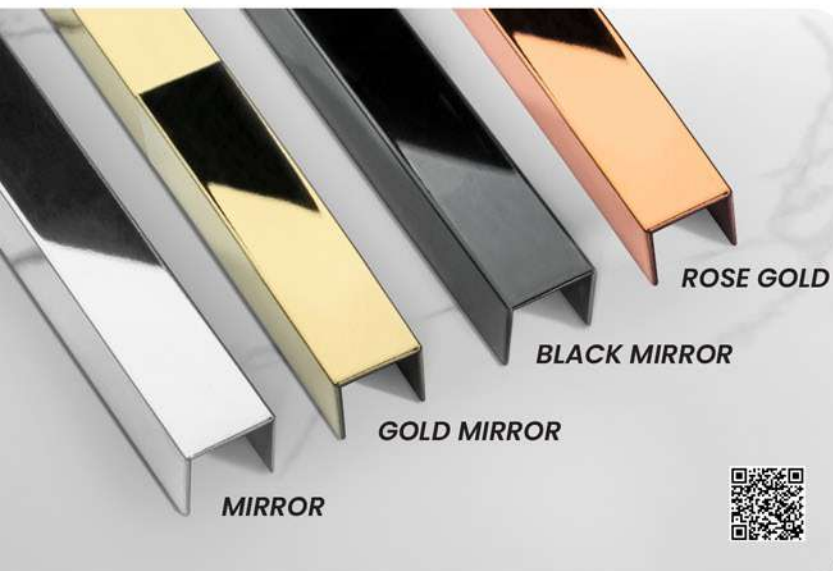
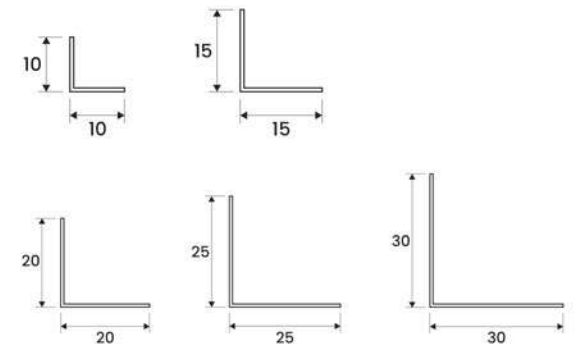

### Plat Strip U PSU

Tersedia Ukuran (mm):

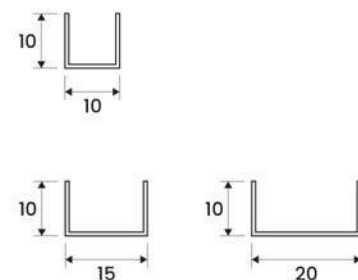





## LIST PLAT STICKER

### LP-STICK

Panjang : **5 meter / ROL**

Material : **Stainless Steel**

Tersedia Ukuran (mm):

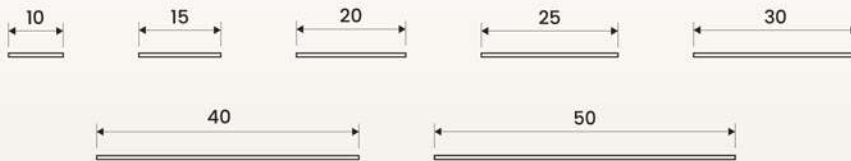

## PROFIL ALUMINIUM

### LIST T

Panjang 3 meter



#### LT-08 & LT-12

- |              |        |
|--------------|--------|
| Anodize      | Black  |
| Silver Pasir | Mirror |
| Gold Mirror  | SS     |

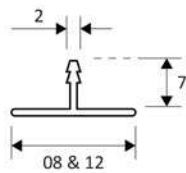

#### LT-15 & LT-18

- |              |        |
|--------------|--------|
| Anodize      | Black  |
| Silver Pasir | Mirror |
| Gold Mirror  | SS     |

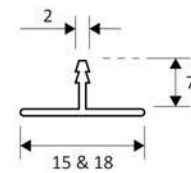

#### LTA-10 / LTA-15 / LTA-18

- |              |        |
|--------------|--------|
| Anodize      | Black  |
| Silver Pasir | Mirror |
| Gold Mirror  | SS     |

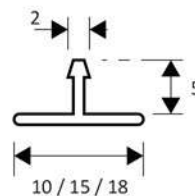

## FRAME

Panjang 3 meter



**FA-19**

- Anodize
- Brush
- Silver Pasir

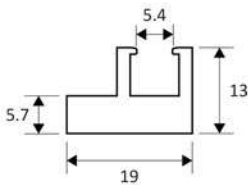

**FA-32**

- Anodize
- Brush

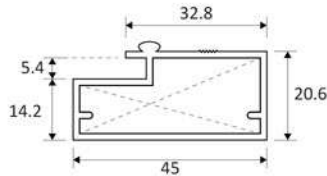

**FA-45**

- Brush
- Silver Pasir

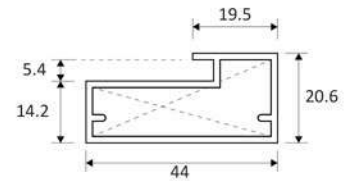

**FA-48**

- Anodize
- Brush
- Silver Pasir

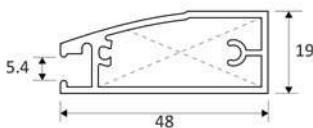

**FB-47**

- Anodize

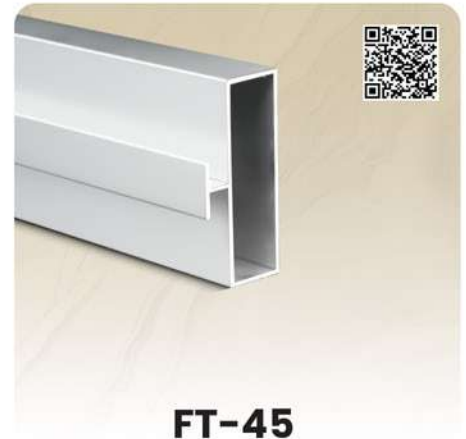
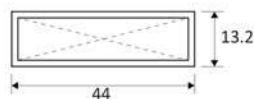

**FT-45**

- Anodize
- Brush
- Silver Pasir
- SS

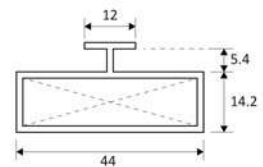

## FRAME HANDLE

Panjang 3 meter



**FA-128**

- Anodize
- Silver Pasir
- Gold Mirror
- Brush
- Black
- Mirror
- SS

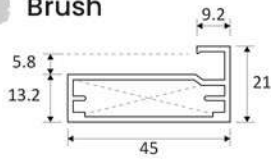

**LENAGA®  
LEFA-128**

- Anodize
- Silver Pasir
- Gold Mirror
- Black
- Mirror
- SS

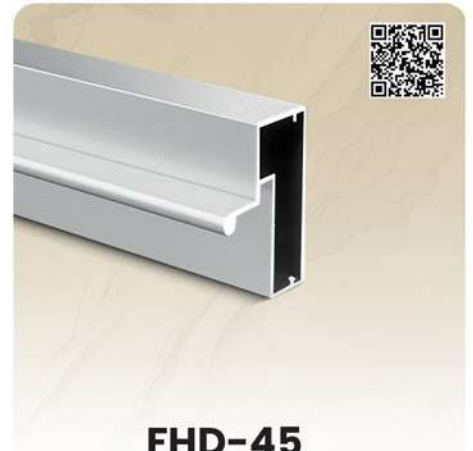
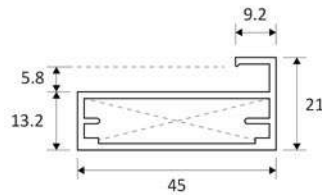

**FHD-45**

- Anodize
- Silver Pasir

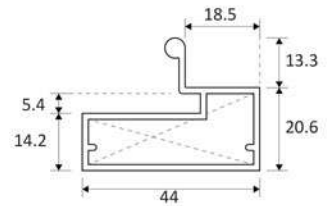

**FHD-127**

- Anodize
- Silver Pasir
- Gold Mirror
- Brush
- Black
- Mirror
- SS

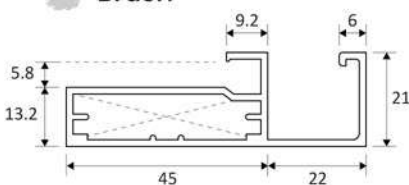

**LENAGA®  
LEFHD-127**

- Anodize
- Silver Pasir
- Gold Mirror
- Black
- Mirror
- SS

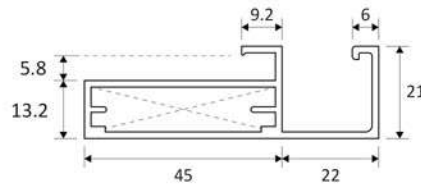

**FHD-46**

- Anodize
- Brush

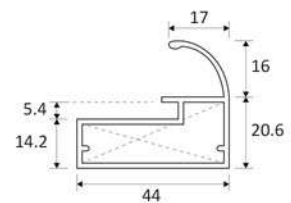

## FRAME HANDLE

Panjang 3 meter



**FHD-128**

-  Anodize
-  Silver Pasir
-  Gold Mirror
-  Brush
-  Black
-  Mirror
-  SS

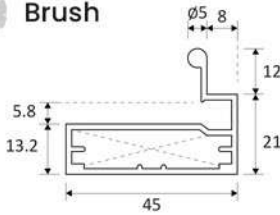

**LENAGA®  
LEFHD-128**

-  Anodize
-  Silver Pasir
-  Gold Mirror
-  Black
-  Mirror
-  SS

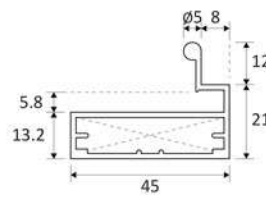

**FHD-129**

-  Anodize

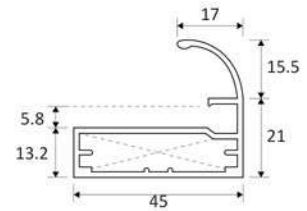

**FHD-130**

-  Brush

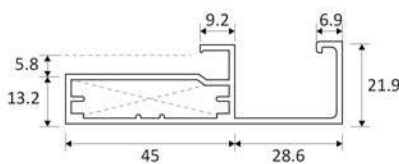

**FA-21**

-  Black
-  Mirror
-  Gold Doff

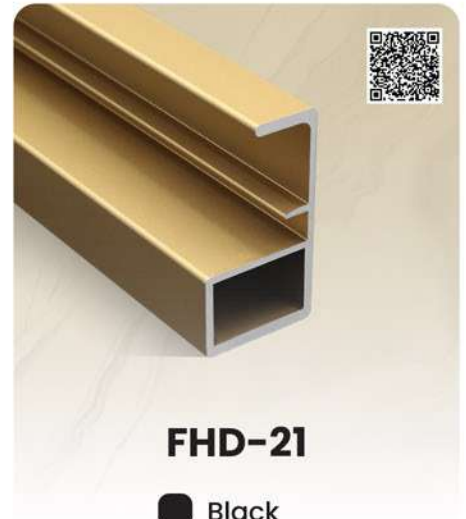
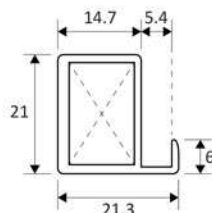

**FHD-21**

-  Black
-  Mirror
-  Gold Doff

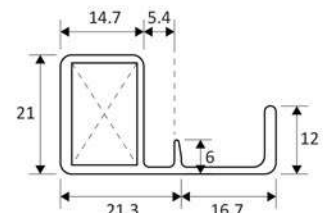

## HANDLE

Panjang 3 meter



- Anodize      Black
- Silver Pasir      Mirror
- Gold Mirror      SS
- Brush

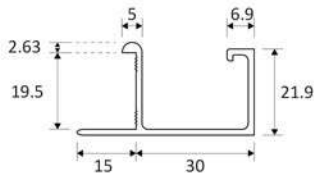

- Anodize      Black
- Silver Pasir      Mirror
- Brush      SS

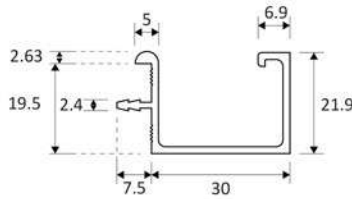

- Anodize      Black
- Silver Pasir      Mirror
- Brush      SS

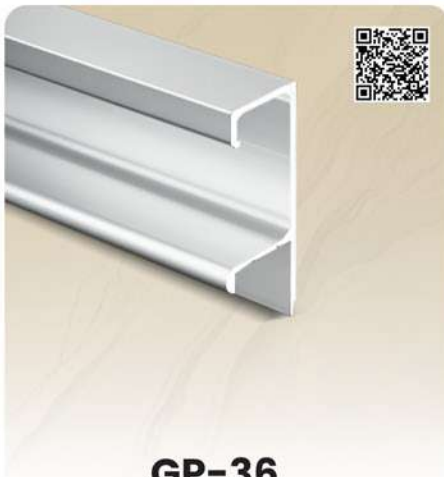
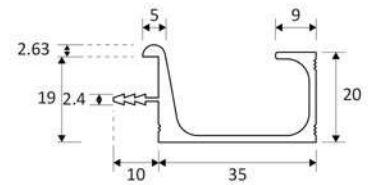

- Black
- Brush
- SS

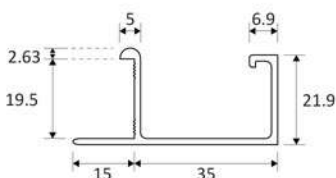

- Anodize      Black
- Silver Pasir      Mirror
- Gold Mirror      SS

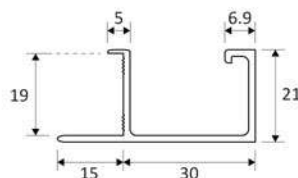

- Anodize      Black
- Silver Pasir      Mirror
- Brush      SS

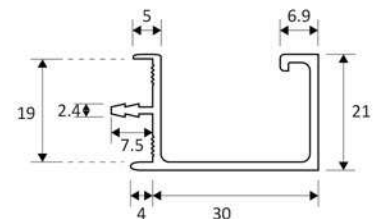

## HANDLE

Panjang 3 meter



**LP-375**

- Anodize       Black
- Silver Pasir     Mirror
- Gold Mirror      SS
- Brush

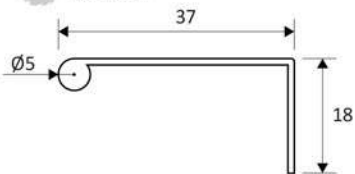

**LP-376**

- Anodize       Black
- Silver Pasir     Mirror
- Gold Mirror      SS

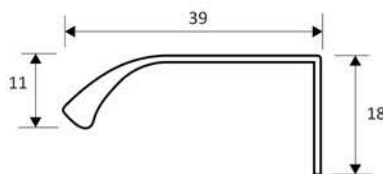

**LP-377**

- Anodize       Black
- Silver Pasir     Mirror
- Gold Mirror      SS

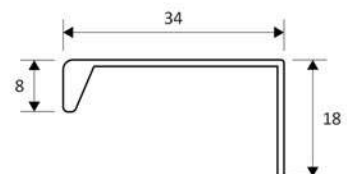

## EDGING



**HUBEN® / LENAGA®  
EA-17 / LEA-17**

- Anodize       Black
- Silver Pasir     Mirror
- Gold Mirror      SS
- Brush

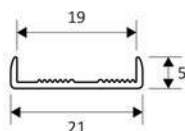

**HUBEN® / LENAGA®  
EA-19 / LEA-19**

- Anodize       Black
- Silver Pasir     Mirror
- Gold Mirror      SS
- Brush

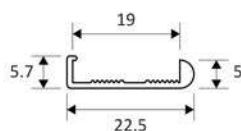

**EA-92**

- Brush
- SS

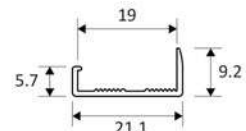

## REL ALUMINIUM

Panjang 3 meter



**HUBEN® / LENAGA®**  
**AS-75 / LAS-75**

-  Anodize
-  Bronze

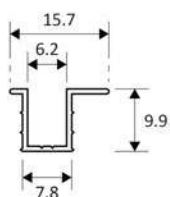

Pasangan roda : SD-75, SD-753, LESD-75



**HUBEN® / LENAGA®**  
**AS-380 / LAS-380**

-  Anodize
-  Bronze

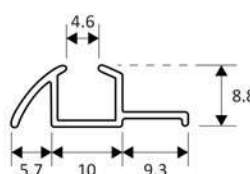

Pasangan roda : SD-380, LESD-380



**HUBEN® / LENAGA®**  
**SD-02-U / LAS-02-U**

-  Anodize
-  Bronze

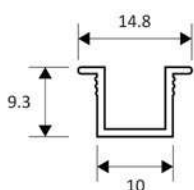

Pasangan roda [Rel Atas] : SD-12, SD-338,  
SD-3141



**HUBEN® / LENAGA®**  
**SD-02-M / LAS-02-M**

-  Anodize
-  Bronze

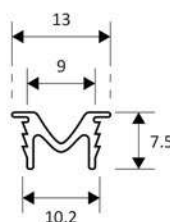

Pasangan roda [Rel bawah] : SD-12, SD-338,  
SD-3141



## REL ALUMINIUM

Panjang 2 & 3 meter



### AS-99-A (Rel Atas)

Anodize

Pasangan roda : RG-99, RG-100

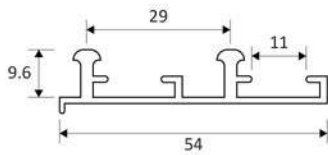

### AS-99-B (Rel Bawah)

Anodize

Pasangan roda : RG-99, RG-100

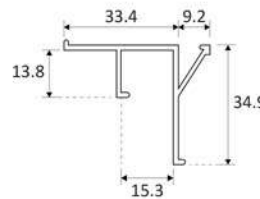

### AS-452-A (Rel Atas)

Anodize

Pasangan roda : SD-452, SD-453

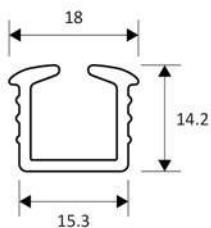

### AS-452-B (Rel Bawah)

Anodize

Pasangan roda : SD-452, SD-453

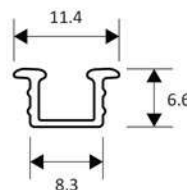

## RAK DAPUR



Dengan Rel Tanem  
*Slow-Motion*



### RD-2-BC Rak Dapur 2 Susun

Material : Besi Chrome  
Ukuran : 300, 400  
Kapasitas Beban : 30 kg



Ukuran Kabinet (L)	Ukuran Rak Dapur P x L x T (mm)
300	480 x 225 x 474
400	480 x 325 x 474

Scan untuk Lihat  
Cara Pasang



RD-2-BC

RD-3-BC



Dengan Rel Tanem  
*Slow-Motion*



### RD-3-BC Rak Dapur 3 Susun

Material : Besi Chrome  
Ukuran : 300, 400  
Kapasitas Beban : 30 kg



## AKSESORIS RAK DAPUR



### KP-01-BC Kerangka Piring

Material : Besi Chrome

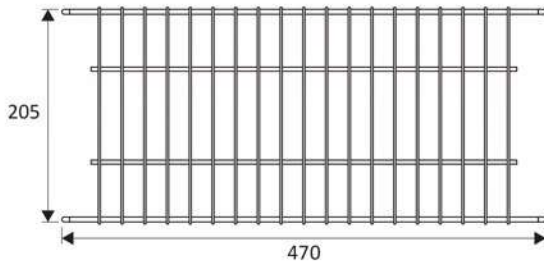
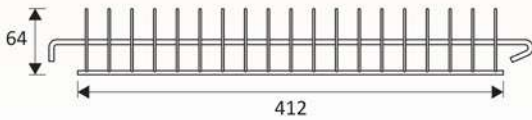
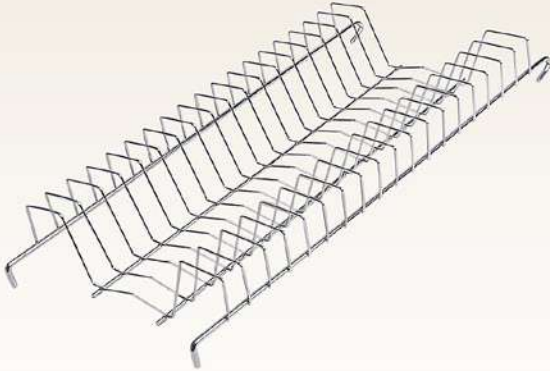

### KB-02-BC Kerangka Botol

Material : Besi Chrome

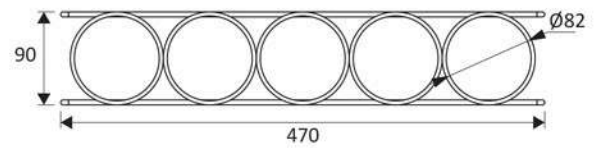
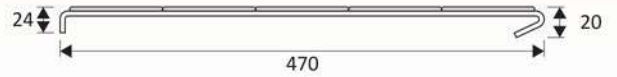
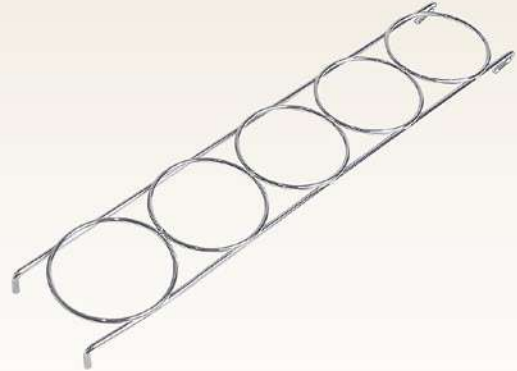

### NAMPAN AIR

Material : Plastik

Ukuran : 300, 400 mm

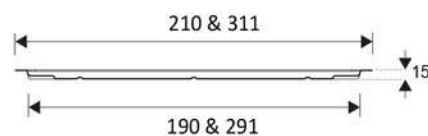
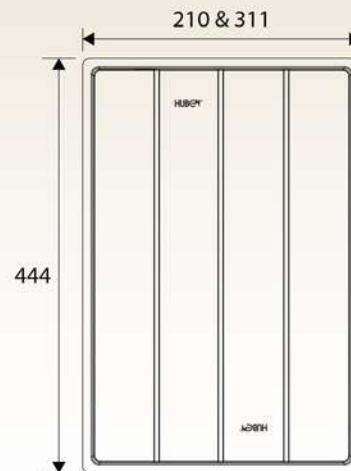



## RAK PIRING

### RP-SS

Rak Piring Gantung Stainless Steel

#### KOMPONEN

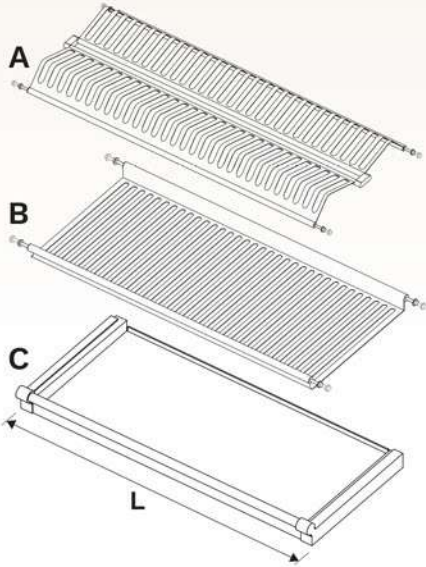

Lebar Kabinet	Lebar Rak Piring L (mm)	Kode Barang
600	550 - 580	RP 600 SS
700	650 - 680	RP 700 SS
800	750 - 780	RP 800 SS
900	850 - 880	RP 900 SS
1000	950 - 980	RP 1000 SS

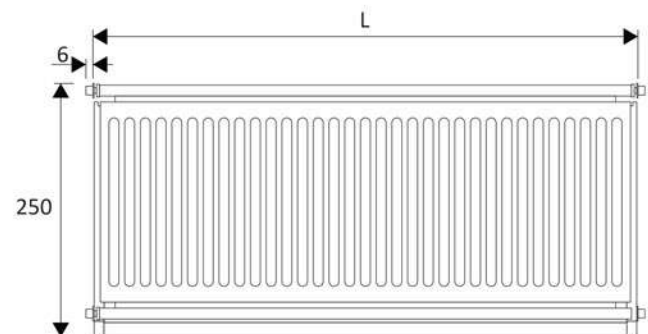
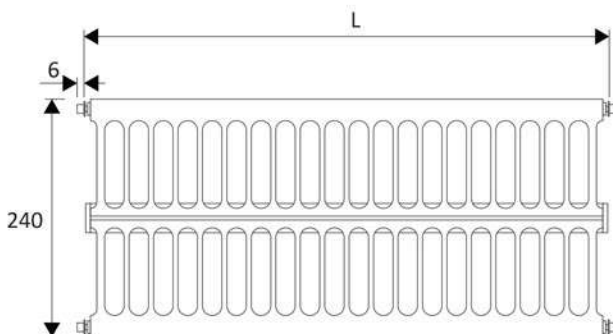
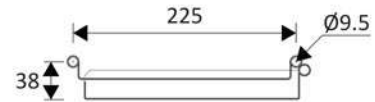
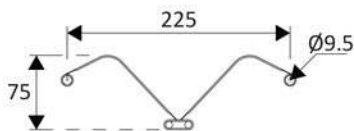

## RODA

### Roda Gantung



Petunjuk pemasangan untuk 2 daun pintu

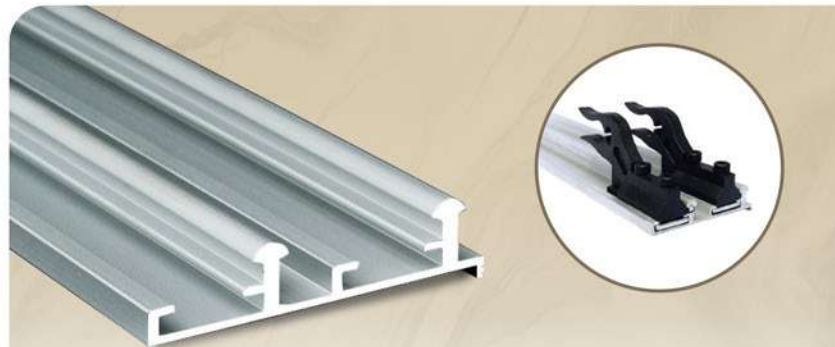
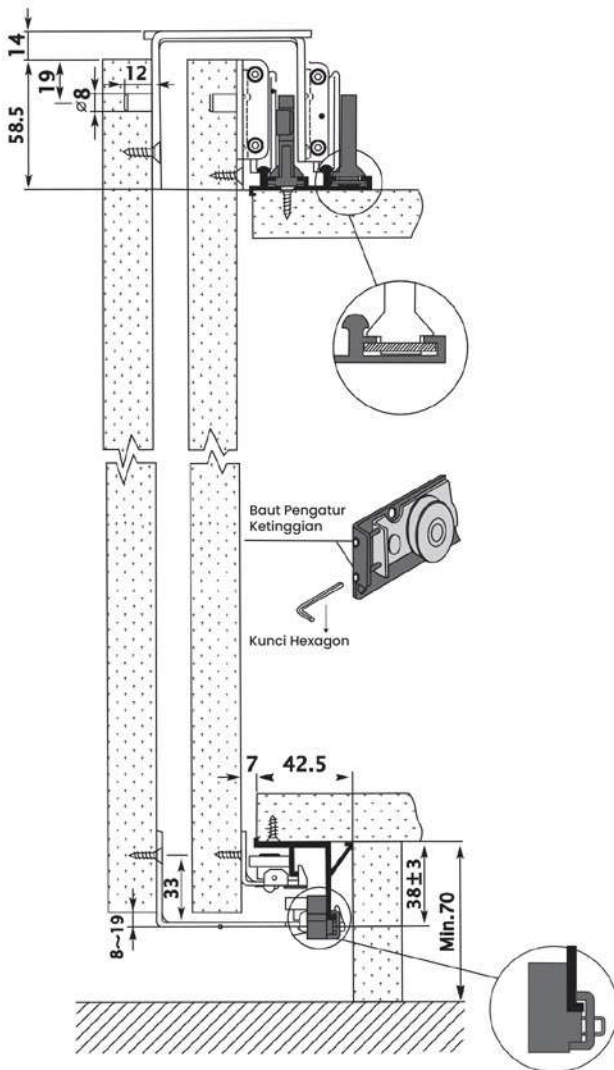

**AS-99-A (Rel Atas)**

Warna : Anodize  
Panjang : 2 & 3 m

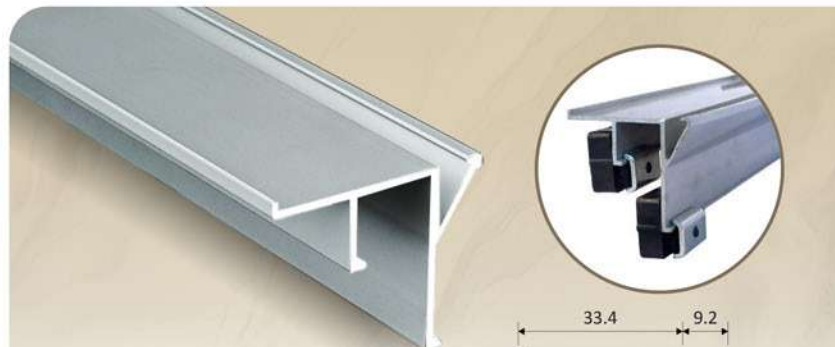
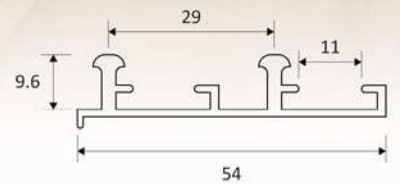

**AS-99-B (Rel Bawah)**

Warna : Anodize  
Panjang : 2 & 3 m

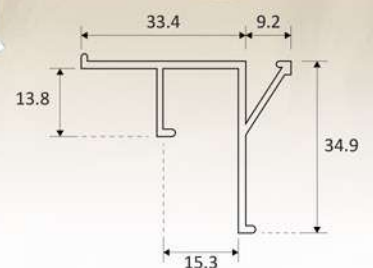



## RG-99 (2 Pintu) & RG-100 (3 Pintu)



**Roda Atas Bagian Luar**

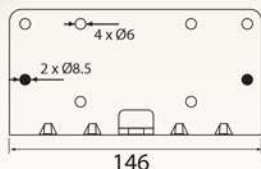

RG-99 (2 pintu) : 1 Set Kiri dan Kanan  
 RG-100 (3 pintu) : 1 Set Kiri dan Kanan



**Roda Bawah Bagian Luar**

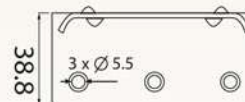

RG-99 (2 pintu) : 1 Set Kiri dan Kanan  
 RG-100 (3 pintu) : 1 Set Kiri dan Kanan



**Roda Atas Bagian Dalam**

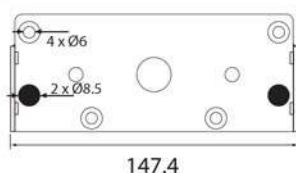

RG-99 (2 pintu) : 1 Set Kiri dan Kanan  
 RG-100 (3 pintu) : 2 Set Kiri dan Kanan

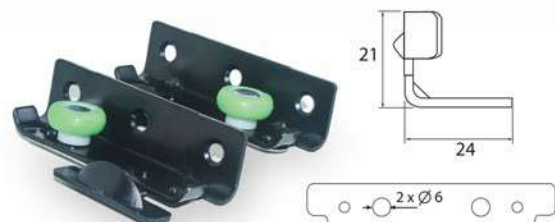

**Roda Bawah Bagian Dalam**

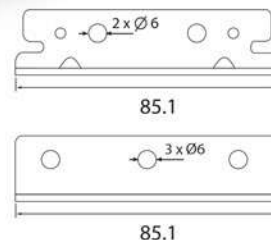

RG-99 (2 pintu) : 1 Set Kiri dan Kanan  
 RG-100 (3 pintu) : 2 Set Kiri dan Kanan



**Stopper Bagian Atas**  
4 Pcs



**Stopper Bagian Bawah**  
4 Pcs



**Kunci Allen**  
4 mm - 1 pc  
3 mm - 1 pc



### DAMPER-99

Damper **Slow-Mo** untuk Roda Gantung RG-99 & RG-100

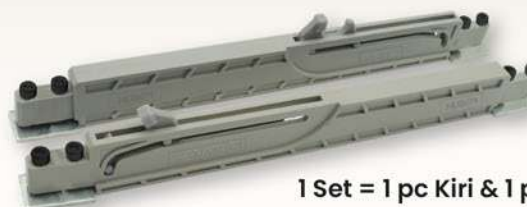

1 Set = 1 pc Kiri & 1 pc Kanan

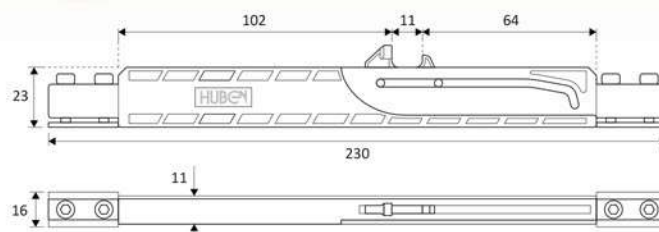

## RODA PINTU SLIDING SLOW MOTION SD-452 (2 Pintu) & SD-453 (3 Pintu)

Scan untuk Lihat  
Cara Pasang



SD-452

SD-453



**SD-452 (2 Pintu)** Roda Atas (Plastik) : 4 Pcs  
**SD-453 (3 Pintu)** Roda Atas (Plastik) : 6 Pcs

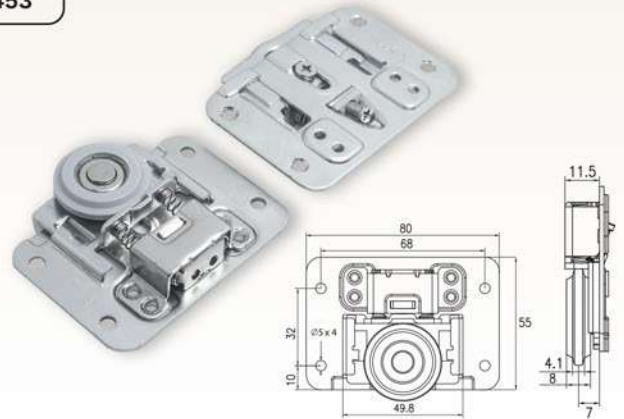

**SD-452 (2 Pintu)** Roda Bawah (Plat Besi) : 4 Pcs  
**SD-453 (3 Pintu)** Roda Bawah (Plat Besi) : 6 Pcs

### Damper

4 pcs

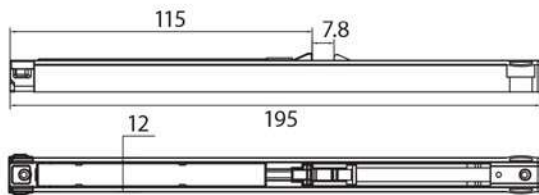

### Kunci Allen

Kunci Allen 2 mm : 1 pc

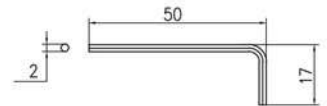

### Skrup

Skrup Tapping Plus 4x16  
SD-452 (2 Pintu) : 32 Pcs  
SD-453 (3 Pintu) : 48 Pcs

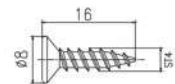

### AS-452-A

Warna : Anodize  
Panjang : 2 & 3 m

Rel Aluminium Bagian Atas  
Untuk Roda SD-452 & SD-453

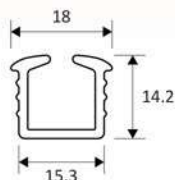

### AS-452-B

Warna : Anodize  
Panjang : 2 & 3 m

Rel Aluminium Bagian Bawah  
Untuk Roda SD-452 & SD-453

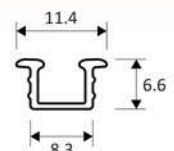

## SD-75 Roda Pintu Sliding

Material : Besi Plat  
Roda : Nylon

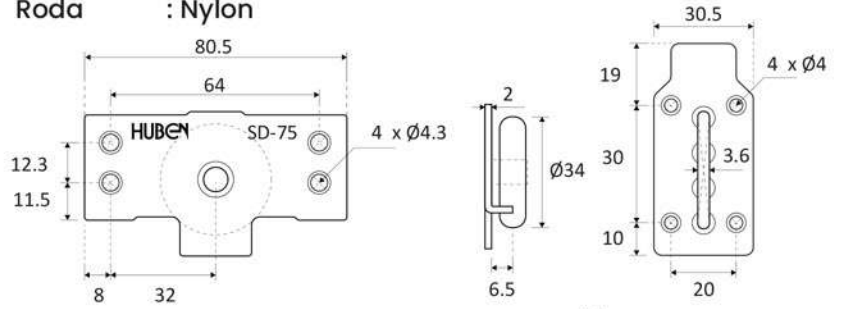

Pasangan Rel:  
AS-75, LAS-75

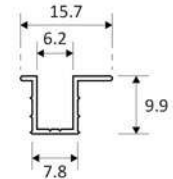

## SD-753 Roda Pintu Sliding

Material : Besi Plat  
Roda : Nylon

Roda Dapat Disetel

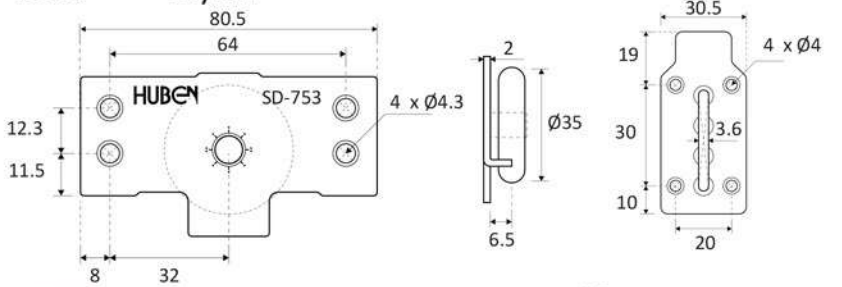

Pasangan Rel:  
AS-75, LAS-75

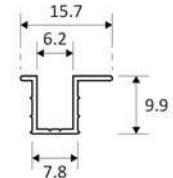

## SD-380 Roda Pintu Sliding

Material : Besi Plat  
Roda : Nylon

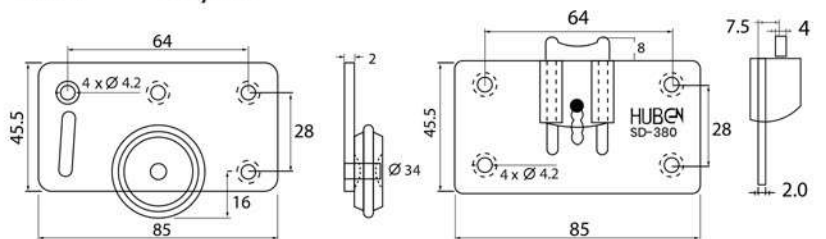

Pasangan Rel:  
AS-380, LAS-380

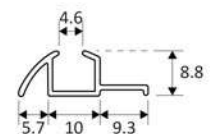





## SD-12 Roda Pintu Sliding

Material : Zinc Alloy  
Roda : Nylon

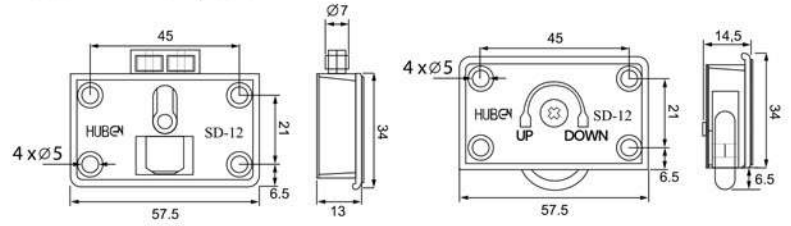

### Pasangan Rel:

Atas : SD-02-U / LAS-02-U  
Bawah : SD-02-M / LAS-02-M

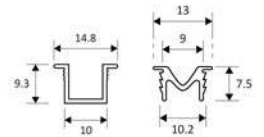

## SD-338 Roda Pintu Sliding

Material : Nylon  
Roda : Nylon

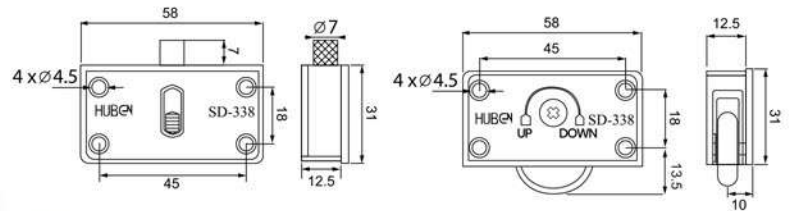

### Pasangan Rel:

Atas : SD-02-U / LAS-02-U  
Bawah : SD-02-M / LAS-02-M

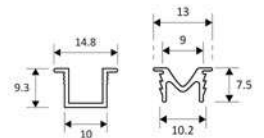

## SD-3141 Roda Pintu Sliding

Material : Nylon  
Roda : Nylon

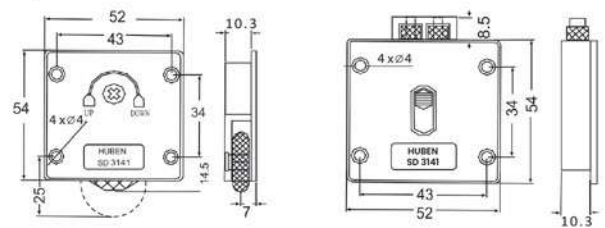

### Pasangan Rel:

Atas : SD-02-U / LAS-02-U  
Bawah : SD-02-M / LAS-02-M

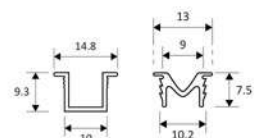



## LESD-75 Roda Pintu Sliding

Material : Besi Plat  
Roda : Nylon

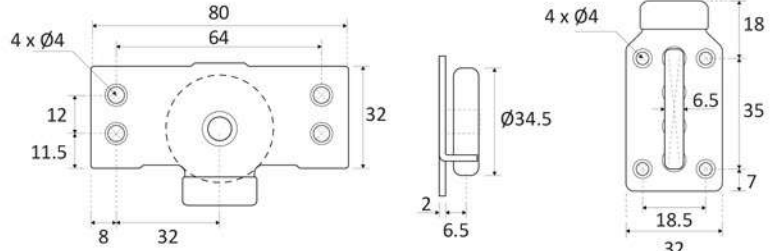

Pasangan Rel:  
AS-75, LAS-75

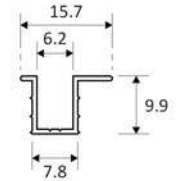

## LESD-380 Roda Pintu Sliding

Material : Besi Plat  
Roda : Nylon

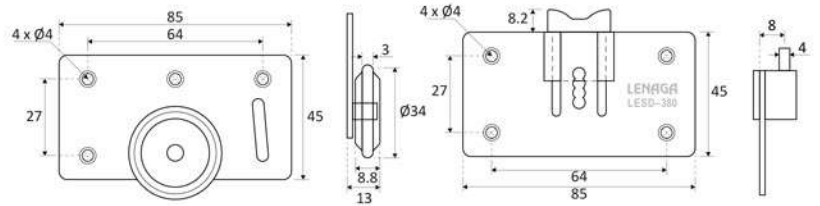

Pasangan Rel:  
AS-380, LAS-380

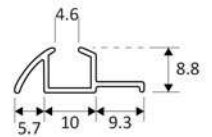

*Segera Hadir*

## REL LACI



30 mm



### FE-30 REL FULL EXTENSION

Material	: Cold Rolled Steel
Finish	: Zinc Plated
Ukuran	: 250 - 500 mm
Minimal kedalaman Kabinet	: Ukuran rel + min. 5 mm
Lebar	: 30 mm
Kapasitas Beban	: 20 kg
Siklus Pemakaian	: 50.000 kali

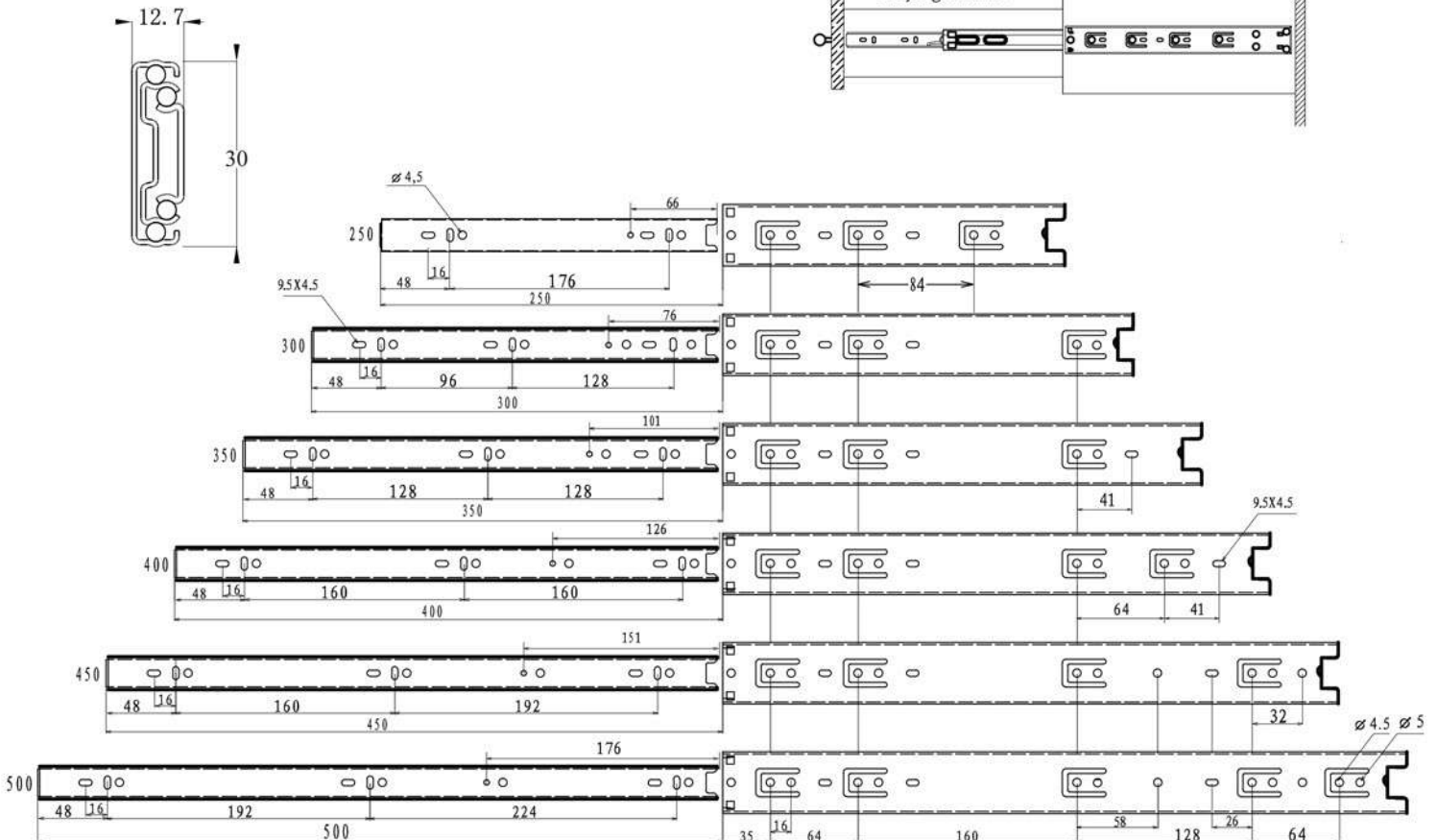
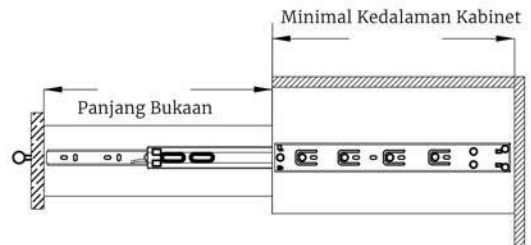
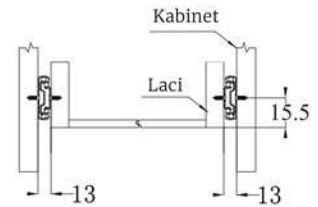



35 mm



## RD-35 REL FULL EXTENSION

Material : Cold Rolled Steel  
 Finish : Zinc Plated (Hitam)  
 Ukuran : 250 - 500 mm  
 Minimal kedalaman Kabinet : Ukuran rel + min. 5 mm  
 Lebar : 35 mm  
 Kapasitas Beban : 25 kg  
 Siklus Pemakaian : 50.000 kali

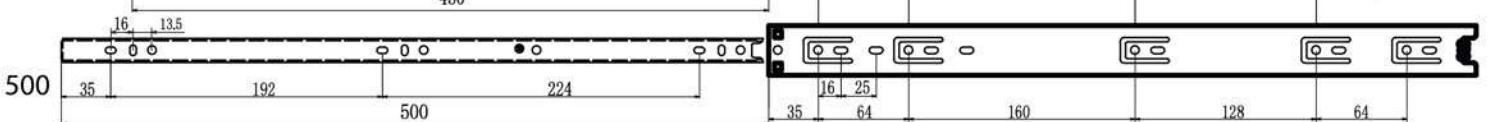
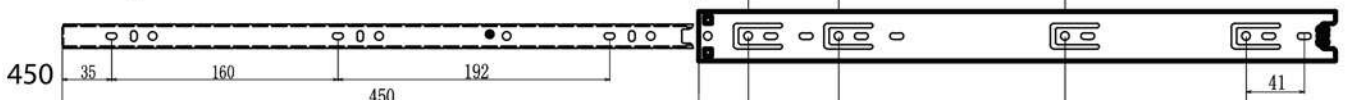
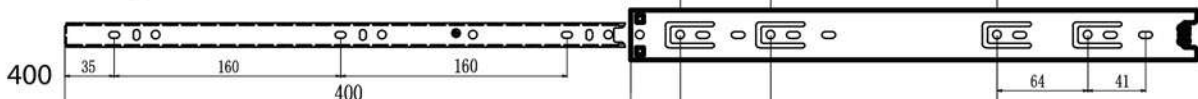
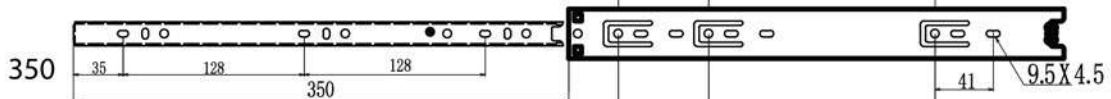
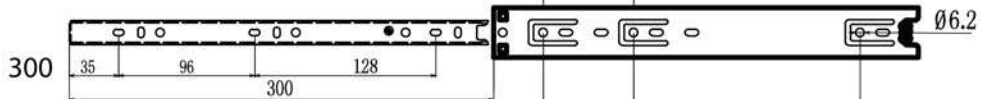
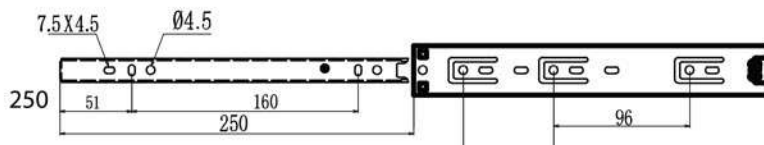
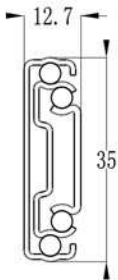
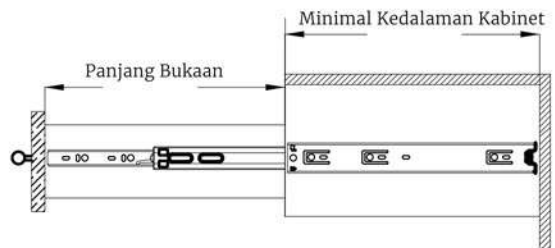
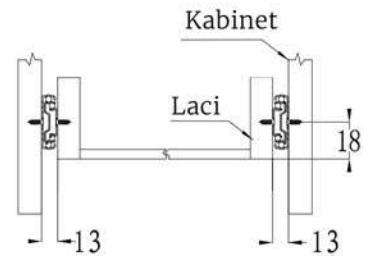



35 mm



## SLOW MOTION



### BM-35

### REL SLOW MOTION FULL EXTENSION

Material	: Cold Rolled Steel
Finish	: Zinc Plated (Hitam)
Ukuran	: 250 - 500 mm
Minimal kedalaman Kabinet	: Ukuran rel + min. 5 mm
Lebar	: 35 mm
Kapasitas Beban	: 25 kg
Siklus Pemakaian	: 50.000 kali

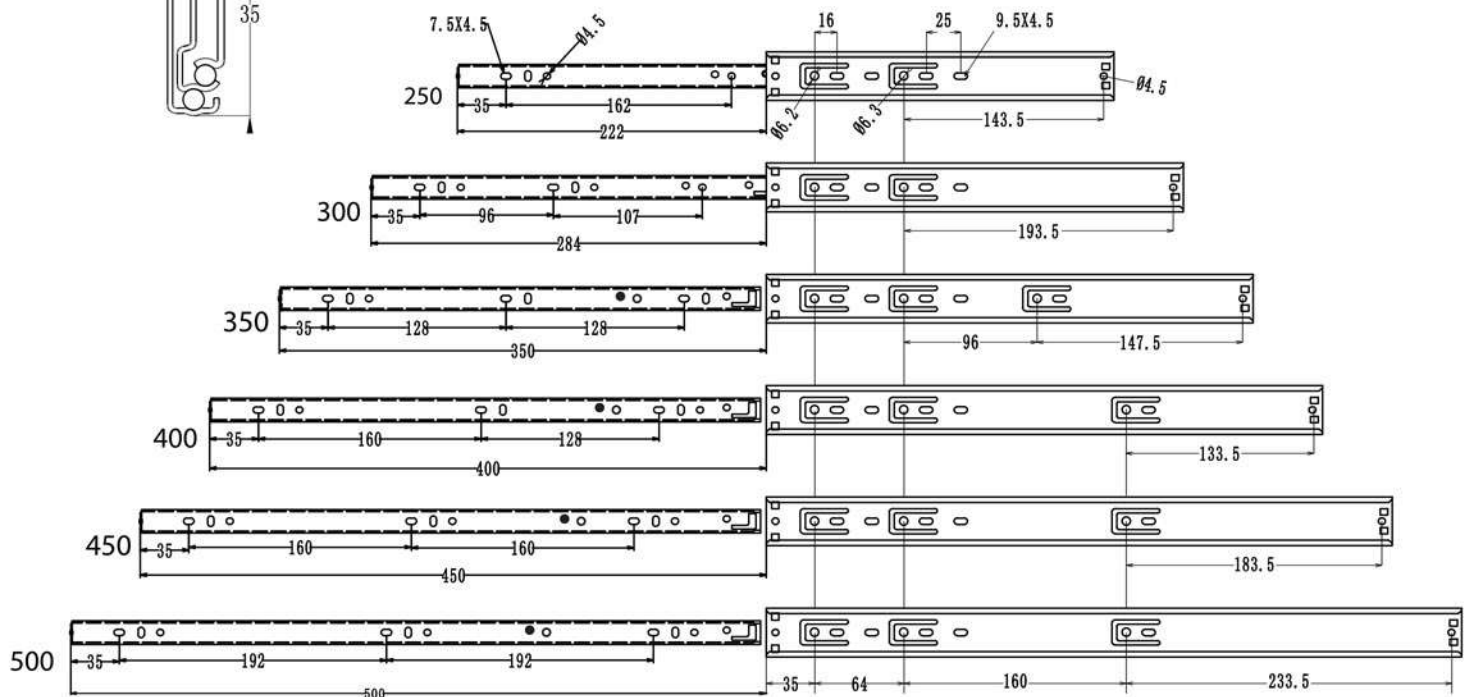
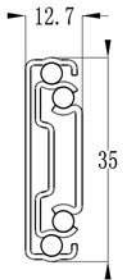
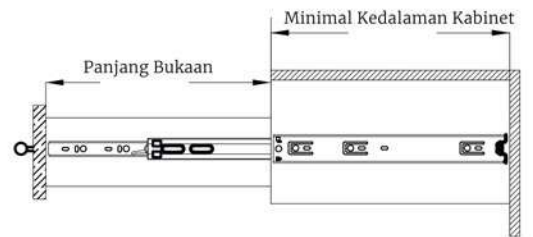
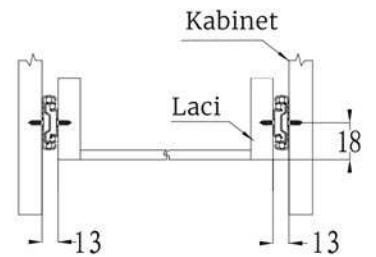



37 mm



## FE-37 REL FULL EXTENSION

Material : Cold Rolled Steel  
 Finish : Zinc Plated (Hitam)  
 Ukuran : 250 - 600 mm  
 Minimal kedalaman Kabinet : Ukuran rel + min. 5 mm  
 Lebar : 37 mm  
 Kapasitas Beban : 30 kg  
 Siklus Pemakaian : 50.000 kali

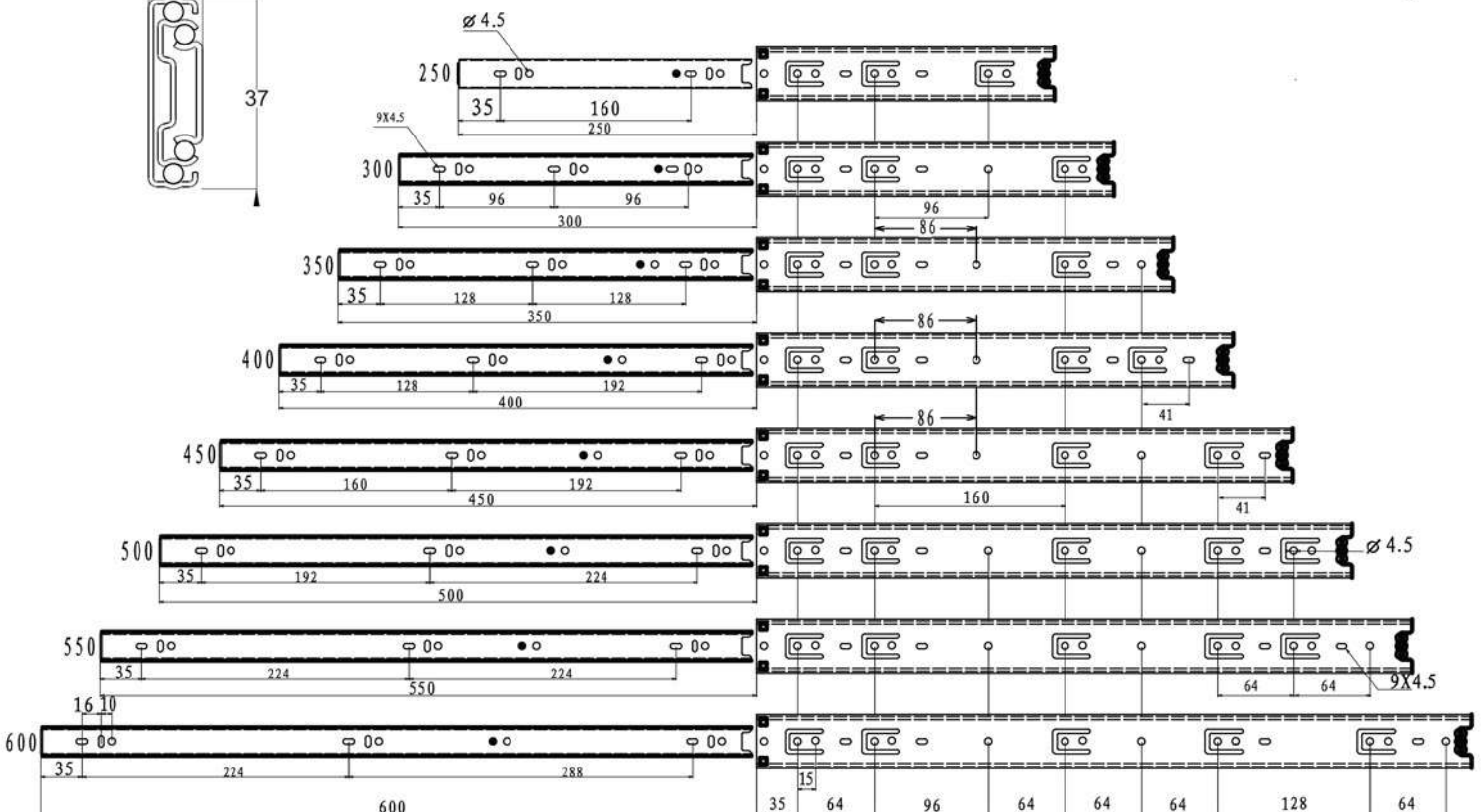
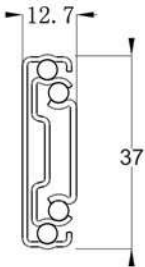
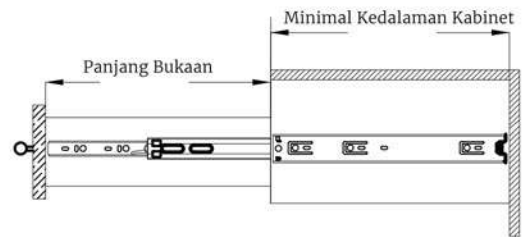
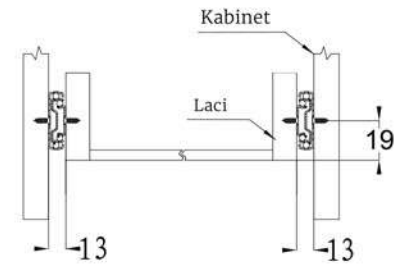



45 mm



## RD-45 REL FULL EXTENSION

Material	: Cold Rolled Steel
Finish	: Zinc Plated (Hitam)
Ukuran	: 250 - 500 mm
Minimal kedalaman Kabinet	: Ukuran rel + min. 5 mm
Lebar	: 45 mm
Kapasitas Beban	: 30 kg
Siklus Pemakaian	: 50.000 kali

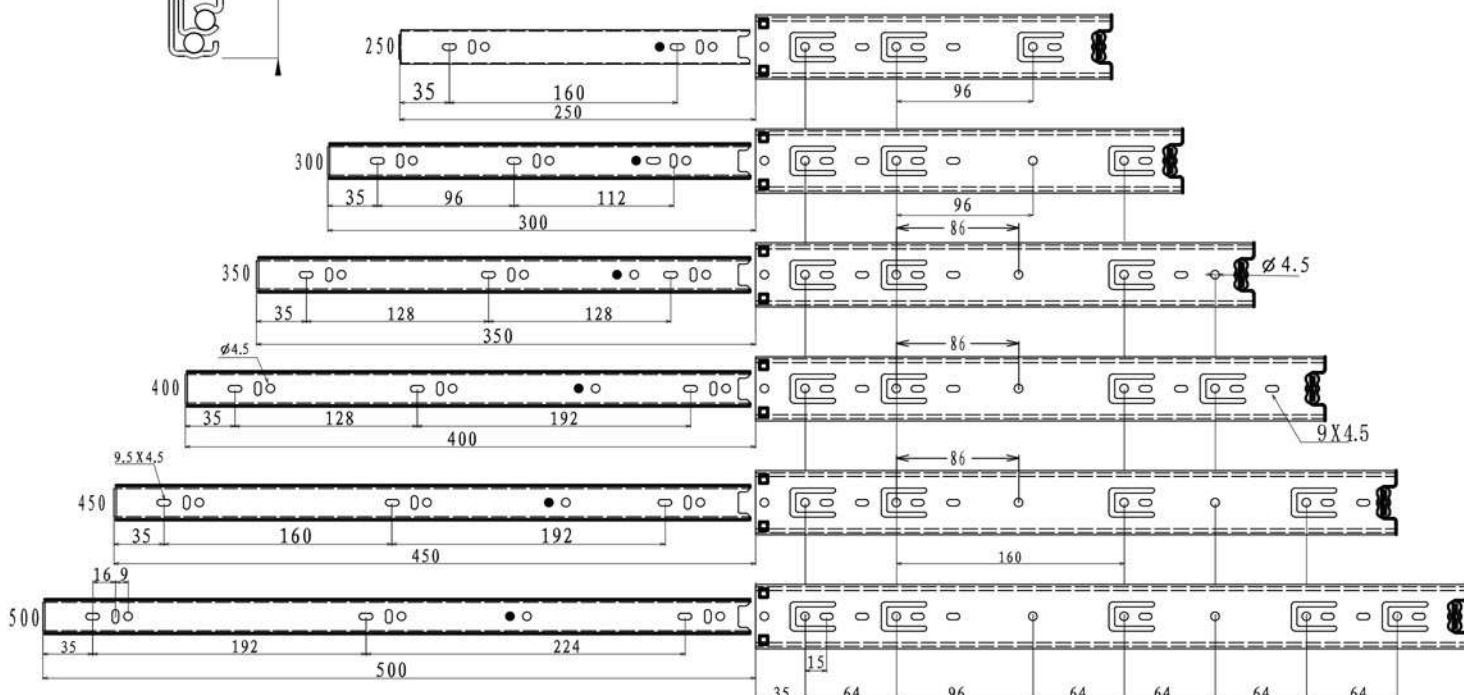
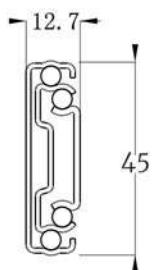
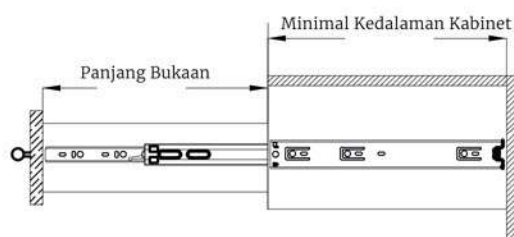
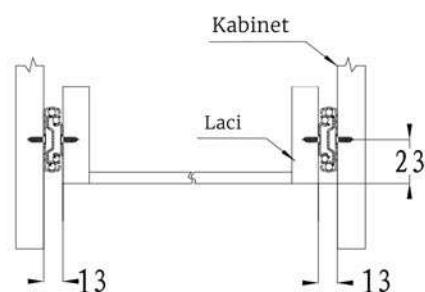



45 mm



## FE-45 REL FULL EXTENSION

Material : Cold Rolled Steel  
 Finish : Zinc Plated (Hitam)  
 Ukuran : 250 - 600 mm  
 Minimal kedalaman Kabinet : Ukuran rel + min. 5 mm  
 Lebar : 45 mm  
 Kapasitas Beban : 35 kg  
 Siklus Pemakaian : 50.000 kali

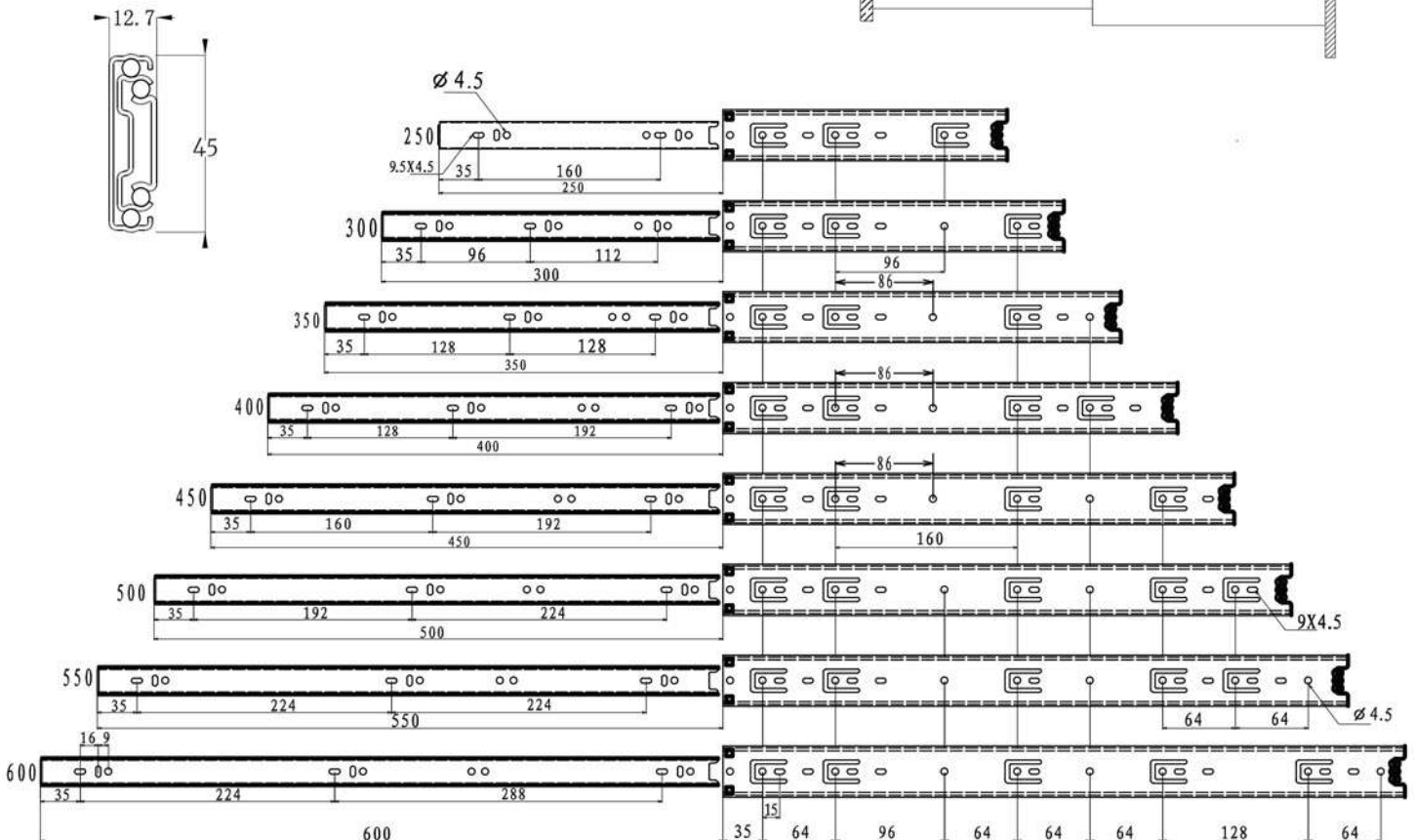
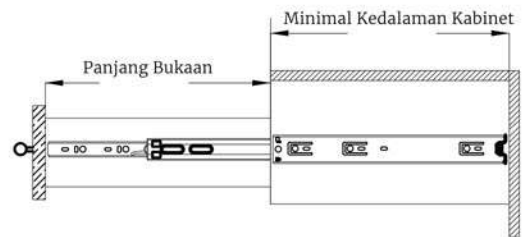
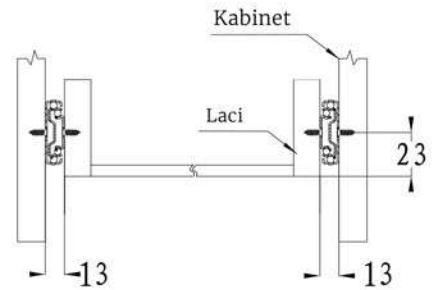



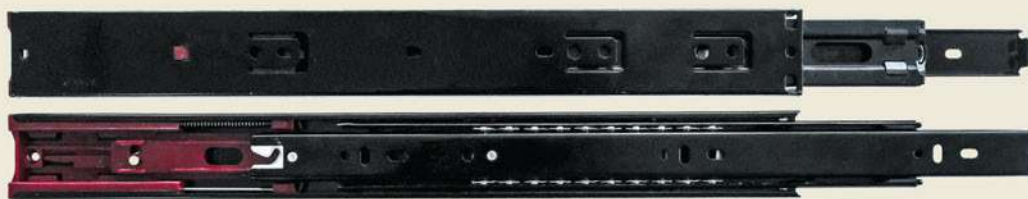

45 mm



## SLOW MOTION



### BM-45

#### REL SLOW MOTION FULL EXTENSION

Material	: Cold Rolled Steel
Finish	: Zinc Plated (Hitam)
Ukuran	: 250 - 600 mm
Minimal kedalaman Kabinet	: Ukuran rel + min. 5 mm
Lebar	: 45 mm
Kapasitas Beban	: 30 kg
Siklus Pemakaian	: 50.000 kali

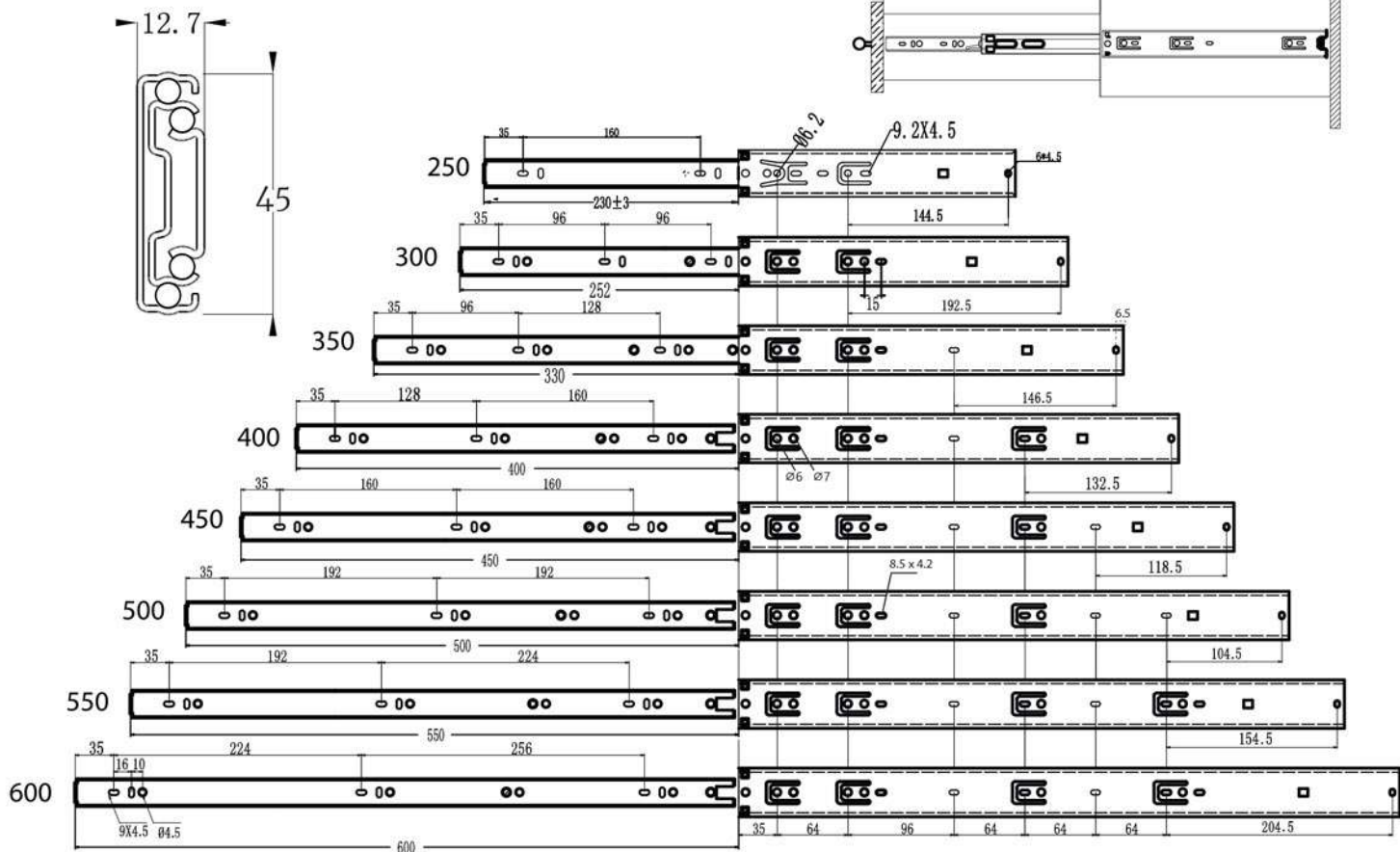
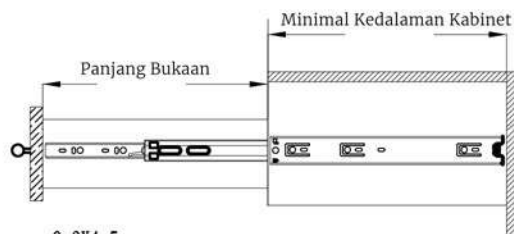
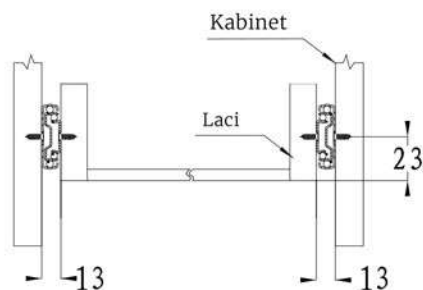



## PUSH-OPEN



### FEPO-45

#### REL FULL EXTENSION PUSH-OPEN

- Material : Cold Rolled Steel
- Finish : Zinc Plated (Hitam)
- Ukuran : 250 - 600 mm
- Minimal kedalaman Kabinet : Ukuran rel + min. 5 mm
- Lebar : 45 mm
- Kapasitas Beban : 30 kg
- Siklus Pemakaian : 50.000 kali

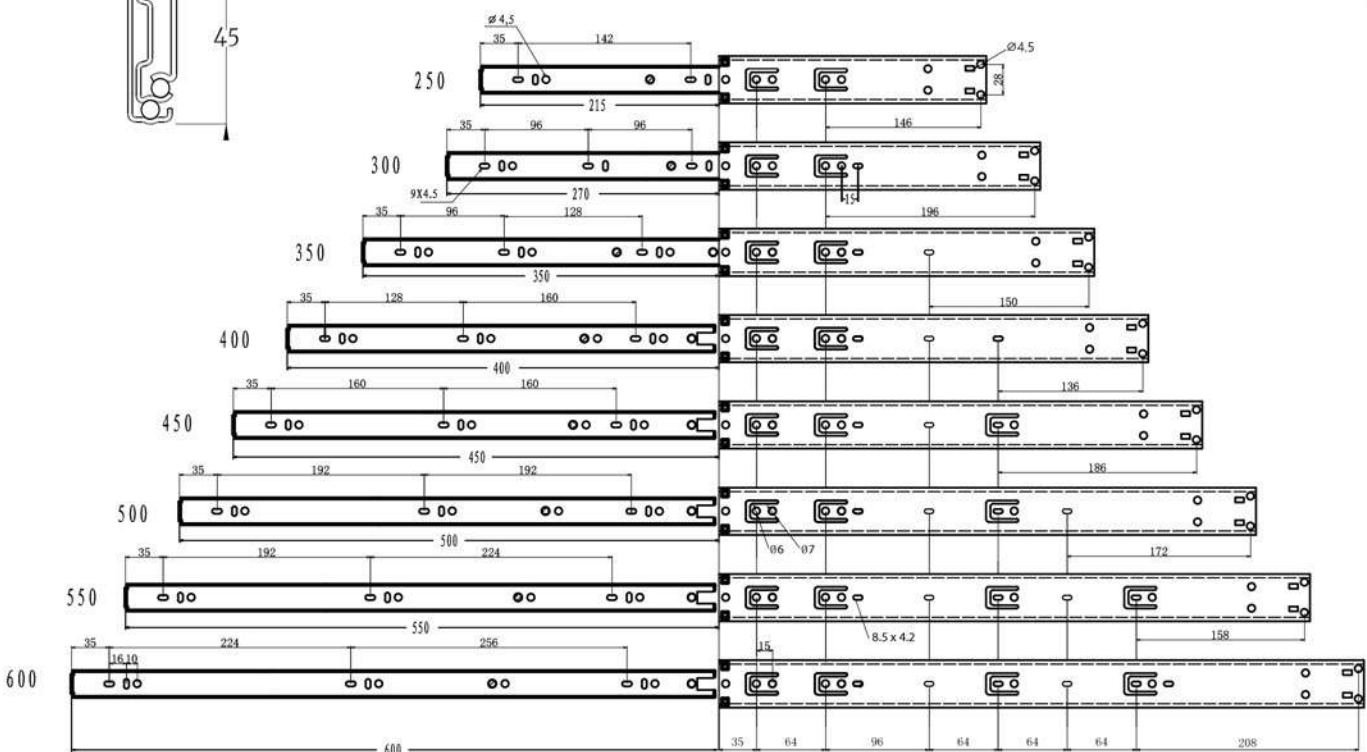
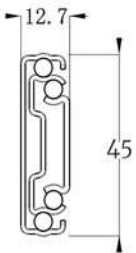
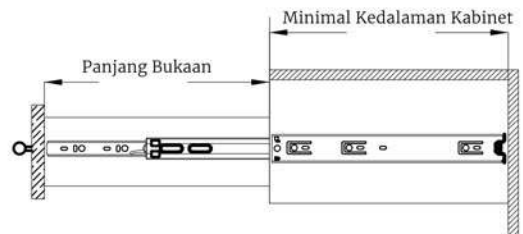
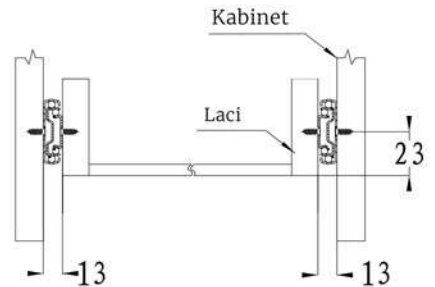



## MS-17 REL MINI SLIDE 17 mm

Material : Cold Rolled Steel  
 Finish : Zinc Plated  
 Ukuran : 246, 310, 374 mm  
 Lebar : 17 mm  
 Kapasitas Beban : 10 kg  
 Siklus Pemakaian : 50.000 kali

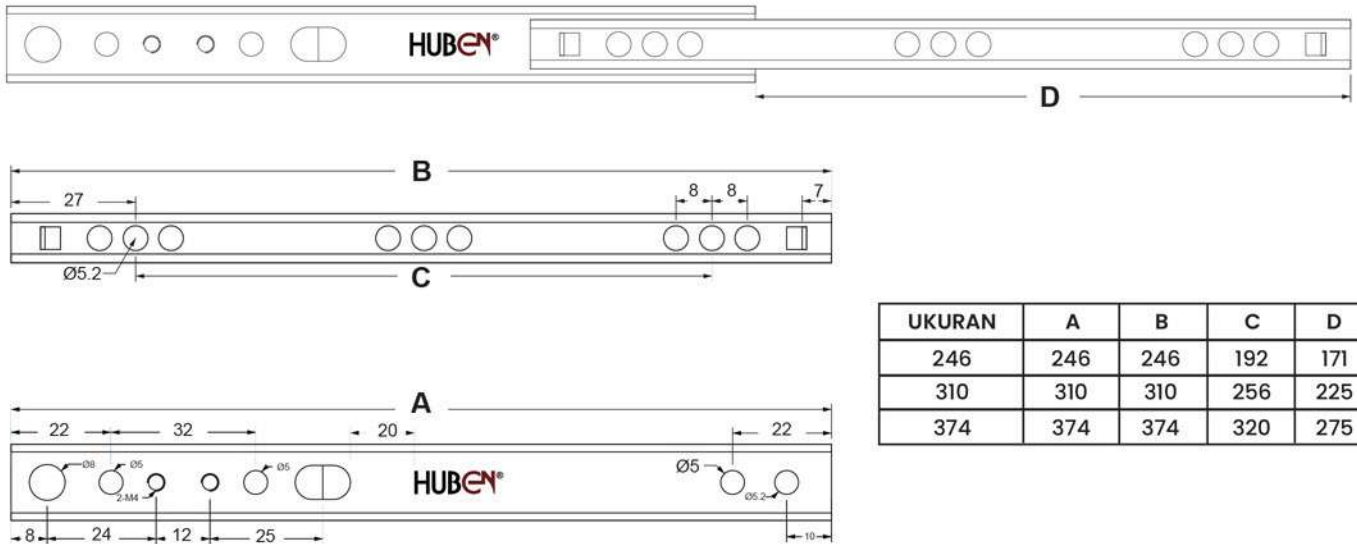
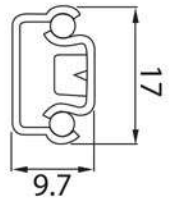



## RLH / RLE REL LACI RODA

Material	: Cold Rolled Steel
Finish	: Beige
Ukuran	: 250 - 600 mm
Kapasitas Beban	: 20 kg
Siklus Pemakaian	: 50.000 kali

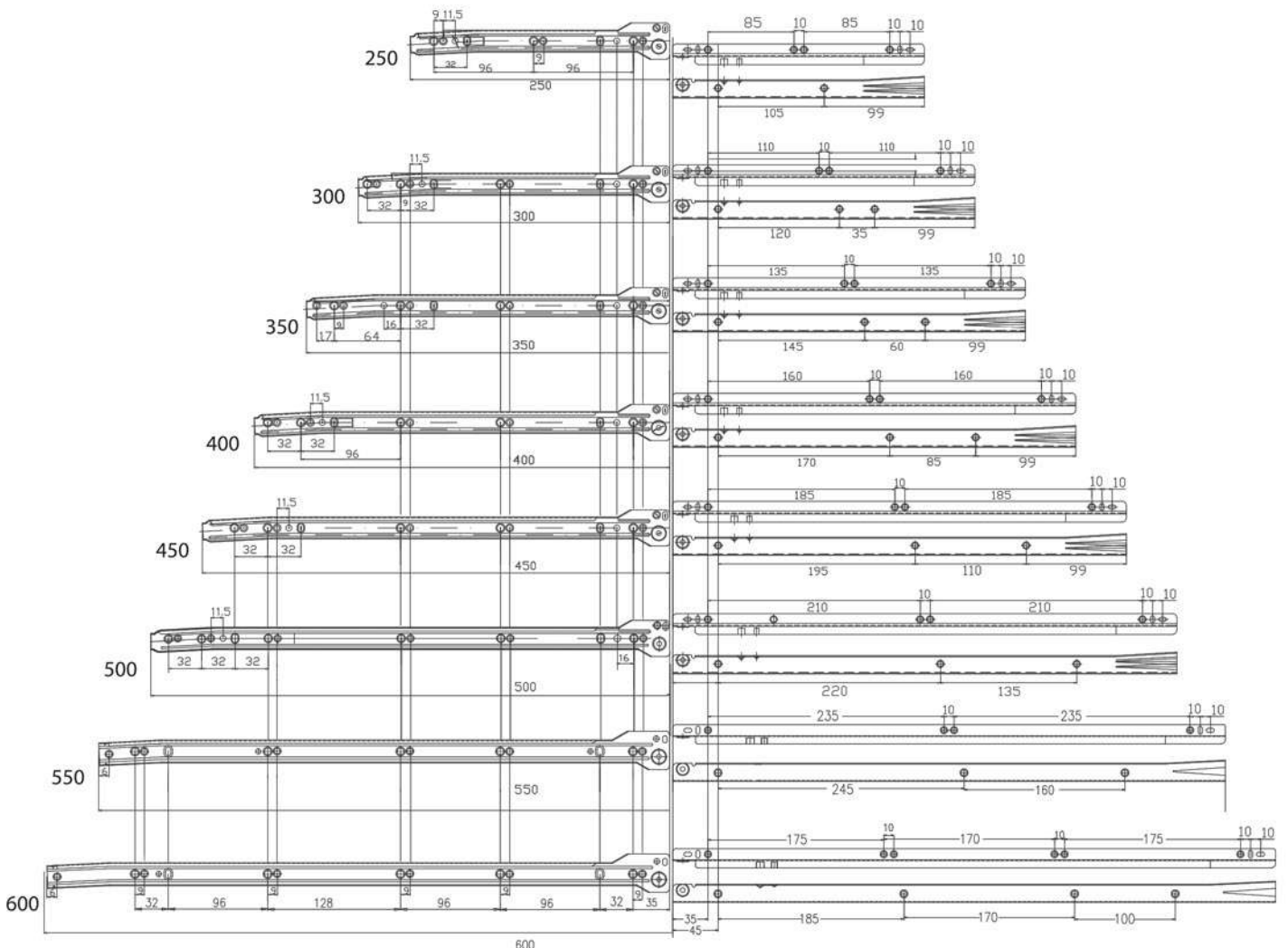



## TN-36-PIN REL TANEM PIN SLOW-MOTION FULL EXTENSION

Material : Cold Rolled Steel  
 Finish : Zinc Plated  
 Ukuran : 250 - 600 mm  
 Kapasitas Beban : 30 kg  
 Siklus Pemakaian : 80.000 kali



Slow Motion

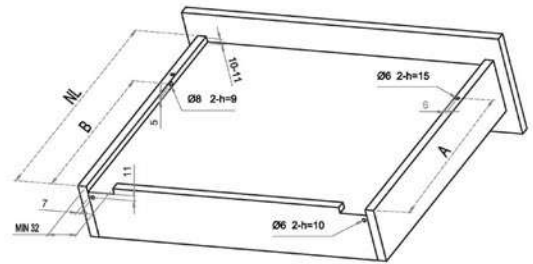
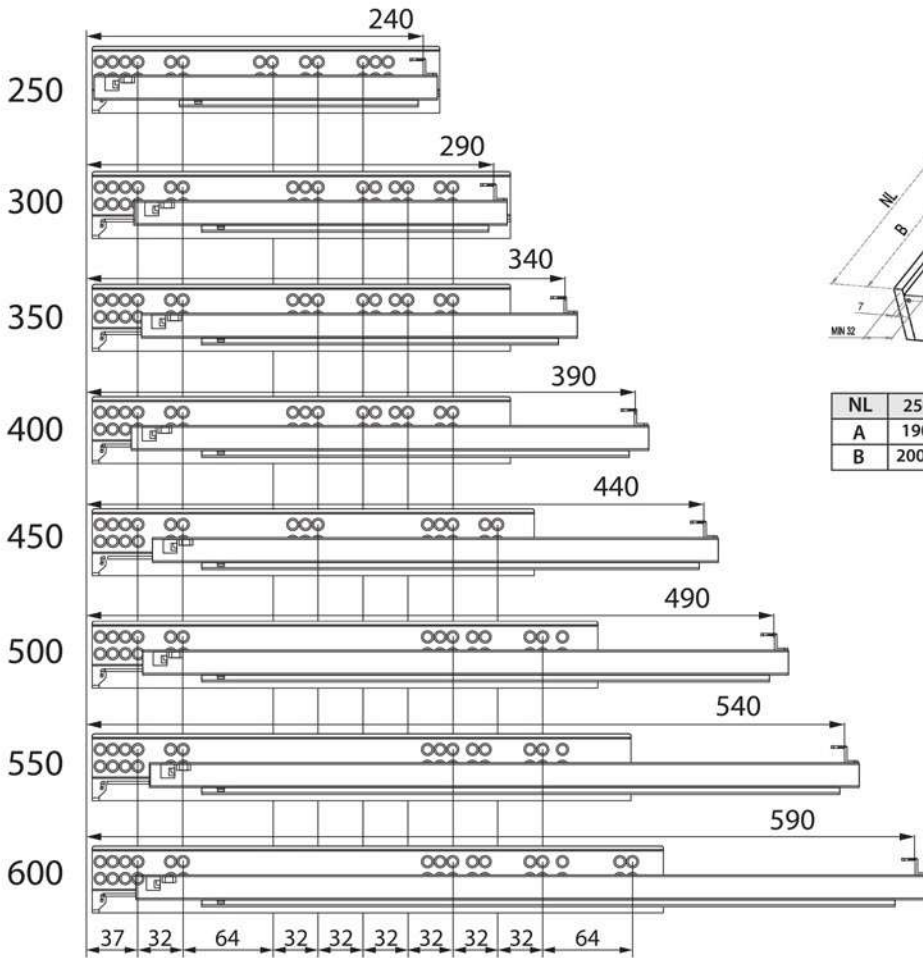

NL	250	300	350	400	450	500	550	600
A	190	245	270	305	330	355	390	415
B	200.5	255.5	280.5	319.5	369.5	419.5	469.5	519.5



Scan untuk video pemasangan

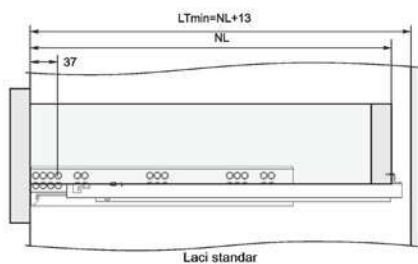
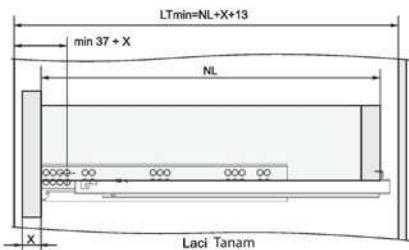

LT - Kedalaman bagian dalam kabinet  
 NL - Nominal panjang rel  
 X - Tebal Maksimum Papan ≤ 16 mm



## TN-37-KO

### REL TANEM **KLIP-ON** SLOW-MOTION FULL EXTENSION

Material : Cold Rolled Steel  
 Finish : Zinc Plated  
 Ukuran : 250 - 600 mm  
 Kapasitas Beban : 30 kg  
 Siklus Pemakaian : 80.000 kali



Scan untuk  
video pemasangan

Sertifikat  
**SGS**

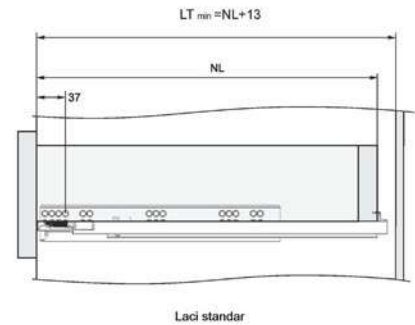
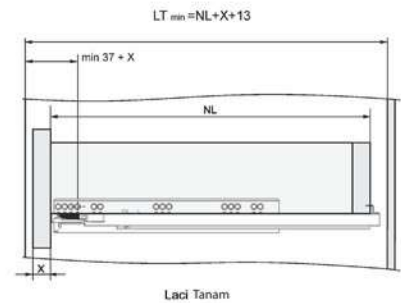
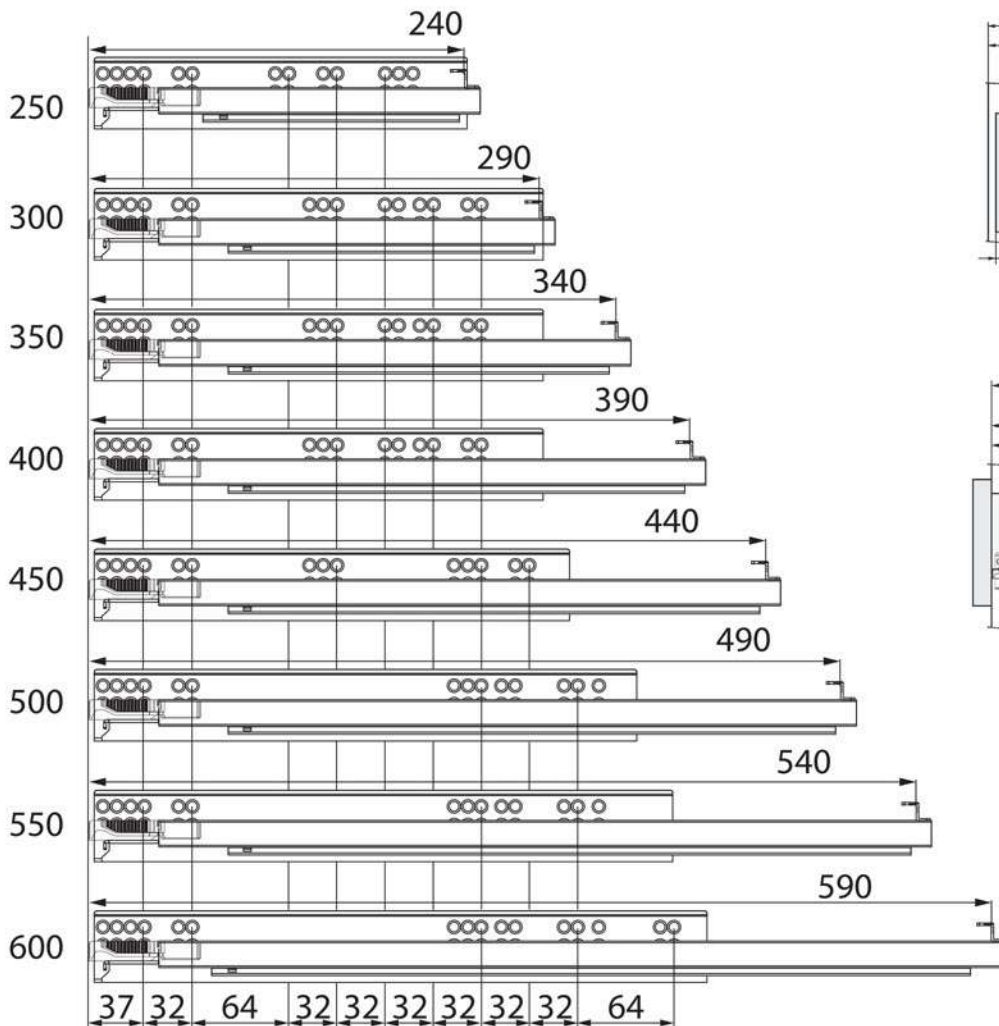

LT - Kedalaman bagian dalam kabinet  
 NL - Nominal panjang rel  
 X - Tebal Maksimum ≤16 mm



## TN-38-PO

### REL TANEM PUSH OPEN **KLIP-ON** FULL EXTENSION

Material : Cold Rolled Steel  
 Finish : Zinc Plated  
 Ukuran : 250 - 500 mm  
 Kapasitas Beban : 30 kg  
 Siklus Pemakaian : 80.000 kali

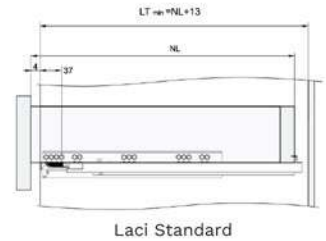
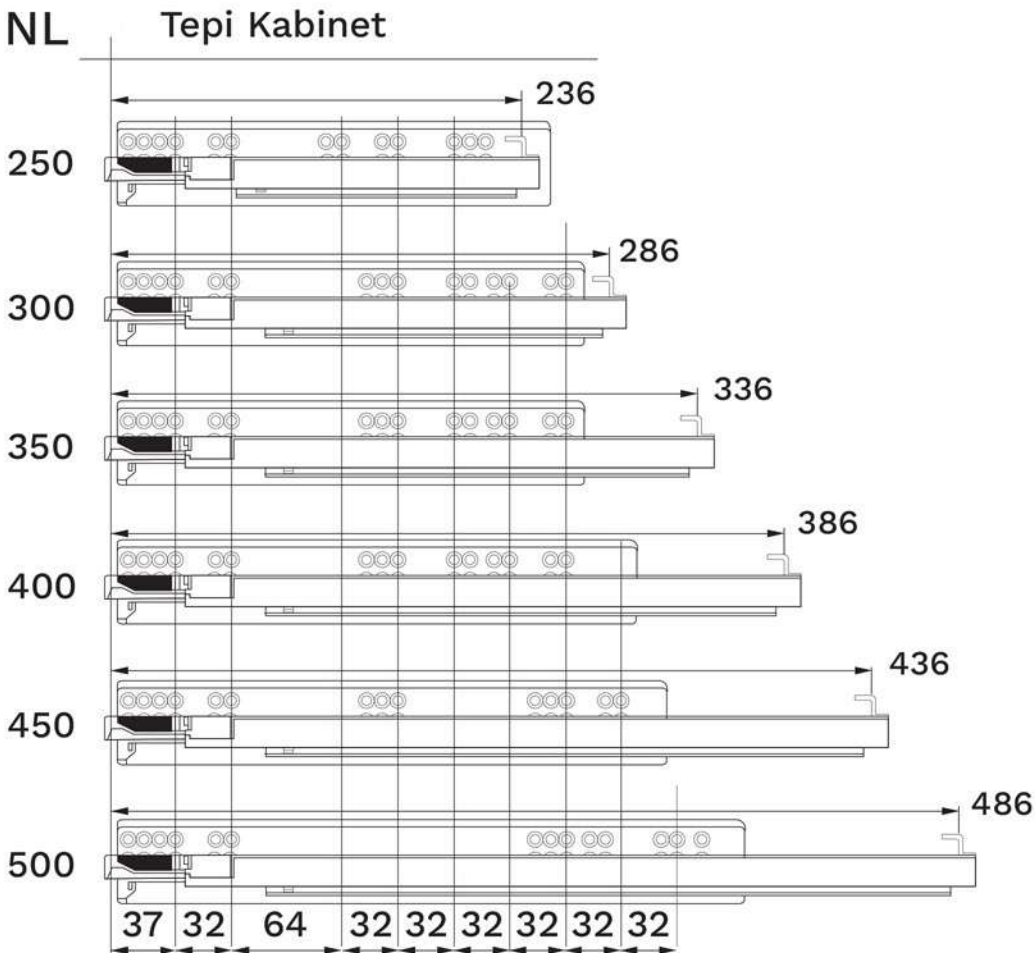

LT - Kedalaman Bagian Dalam kabinet  
 NL - Nominal Panjang Rel

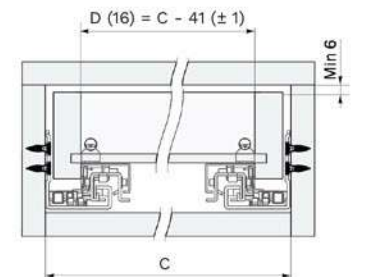

C - Lebar Bagian Dalam Kabinet  
 D - Lebar Bagian Dalam Laci ( $\leq 16$  mm)

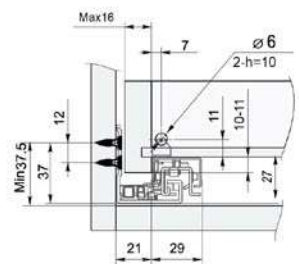

# HUBEN<sup>®</sup>

## TARIKAN

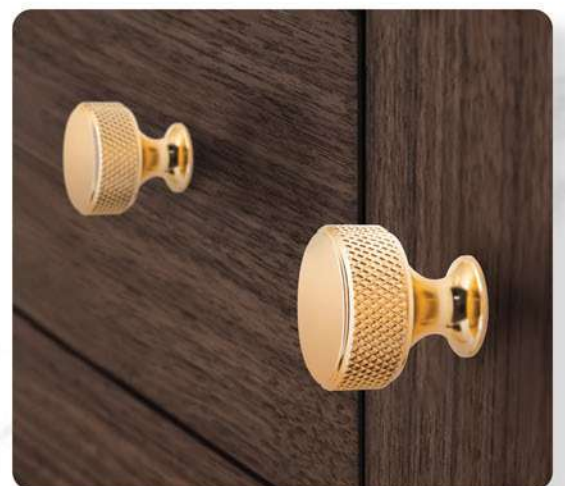

Akses Online  
Katalog Tarikan



Request  
Katalog Huben







**HUBEN<sup>®</sup>**  
INSIDE

**LENAGA<sup>®</sup>**

## FURNITURE FITTINGS & LIGHTING



Form Request  
Spanduk & Katalog



@hubenindonesia



Huben Indonesia



Huben Indonesia



@hubenindonesia